

€ Senza IVA 61/2021  
Valida fino al 31/01/2022



# ***SUPEROFFERTA*** ***2021***



79%



Articolo	Pag	Articolo	Pag	Articolo	Pag	Articolo	Pag	Articolo	Pag	Articolo	Pag	
<b>0</b>												
001 RV	28	270 BM	83	426 D/S4	90	519 M 280HGTS	23	601 1/4-1/2 J100	59	922 BR1	97	
001 TRV	28	270 C/C3	83	426 SAB	90	519 M 280N1	23	601 1/4-1/2 J82	59	923 A	96	
002 JMA	24	272 DS	82	443 N	86	519 M 280TK	23	601 1/4-1/2 JTX16	58	926 A	67	
002 JTMA	25	276 CE/SE8	53	443 NC	86	519 M 285A1	23	606 1/2 EA	54	927 MN	83	
002 UDE	27	280 HAP/SE6	41	446 E/SE2	86	519 M 285A2	23	606 1/4 EA	54	928 AC1 1/2	94	
002 UDM	26	280 HATX/SE6	41	447 T	82	519 M 285KA	23	606 1/4 SK	57	928 D1 3/4	95	
007 FTSV	30	280 HG/SE6	41	451 N/S4	48	519 M 322H	23	608 1/4 EAK	56	929 PC1 1/2	92	
007 MLV	65	280 HGTS/SE6	41	454	48	519 M 322STX	23	609 1/4 EB	57	929 PC1/C12	93	
007 MV	65	280 LTS/S9	40	458 E/B9	46	519 M 324H	23	610 1/4 EFK	57	939 C1	96	
007 RV	31	280 LTSTX/S8	40	458 S20	47	519 M 324STX	23	612 1" ESI	55	942 PC3 1/2	92	
007 SV	30	280 T/SE7	42	458 S6	48	519 M 382F	23	612 1/2 MPA	55	942 PC3/C7	93	
007 TV	30	280 TK/SE6	43	460 A	48	519 M 613AEA	23	612 3/4 B	55	942 PD1 3/4	95	
007 V	31	280 TSTX/SE4	43	468 M	89	519 M 613BEA	23	612 3/4 EB	55	942 PE1 1	95	
007/1V	31	280 TTS/SE6	43	493 A	74	519 M 613CEA	23	622 K/S1	71	942 PEL2 1	95	
074 A	65	280 TTX/SE8	42	493 B	74	519 M 990A5MD	23	640 A	29	943 PC1 1/2	92	
076 G	65	280 XLTS/S9	40	493 C	74	519 R6/3A-S	13	641 TA	28	943 PC1/C12	93	
085 EX/SE2	38	283 SE9	52	495 098HYB	79	519 R6/3I-S	13	641 TB	28	943 PC2 1/2	94	
085 EX/SE3	38	285 DS8	50	495 A-PL	21	519 R6/3NV	11	641 TC	28	981 A	75	
091 D/SH5	34	285 KA/DS12	51	495 A-SP	20	519 R6/3V	11	646/5LV	29	984 MN	75	
091 SH5	34	285 KA/DS8	51	495 I-PL	21	519 R6/3VFULL	16	646/5V	29	987 E/S3	70	
091 SH8	34	285 KB/SR8	52	495 I-SP	20	519 R6/4NV	11	664 B/S7	45	987 F/S3	70	
098 3/8 HYB8	79	285 KF/DS8	52	495 MA	20	519 R6/4V	11	664 S25	45	988 D/S3	72	
<b>100</b>												
127 C/SE4	39	285 SE26	50	<b>500</b>		519 R6/5V	11	687 1/2 C16	98	988 E/S10	72	
127 C/SEAS	39	294 AC	49	501 P	19	519 R7/3V	11	688 3/4 MD6	98	988 G/S12	72	
127 N/SE4	39	294 AD	49	502 R2V	17	519 R8/3M-S	14	692 J32	44	988 LA/S14	72	
127 N/SE4S	39	294 AG	49	504 S	17	519 R8/3V	11	692 J49	44	988 MA/S19	72	
135 B	37	299 SE4	53	506 BA	18	519 RA1	16	692 J100	44	988 MA/S25	72	
146 B	64	299 SN/SE4	53	506 BAC	19	519 RA2	16	<b>700</b>			995 A	67
150 AX/SE2	36	<b>300</b>		506 BLC	19	519 RA3N	16	751	64	995 AF	66	
150 AX/SE3	36	305 N	62	513 B6V	17	519 RA4	16	753 KA	64	995 AL	66	
150 AX/SP2	37	307 A/S7	62	514 B6V	17	519 RA5	16	767	64	995 K	67	
155 AX	37	314 C	62	516 SA/C1	6	519 RA6	16	<b>800</b>			997 A	73
163	64	317 K	62	516 SA/C2	6	519 RA8	16	810 F	60	997 B	73	
178 N	37	322 SH10	35	516 SA/C3	7	519 RA9	16	810 N	60	<b>1000</b>		
<b>200</b>												
200 S	73	322 SH7	35	516 SA/C4	7	519/127N	22	810 N	60	1612 BA12	81	
207 D	63	322 STX/S7	35	516 SA/CA1	6	519/150AX	22	812 N	60	1612 BA24	81	
207 E	63	324 LPH	33	516 SA/CA2	6	519/276	22	814 A	61	1613 AGM 12-24	80	
218 N	71	324 SH12	33	516 SA/CA3	7	519/280HG	22	828 X4	61	1613 OBD	81	
233 1/2 MNTX/C6	98	324 SH5	32	516 SA/CA4	7	519/280HGTS	22	831 A	61	1613 RA12	80	
233 1/2 MXZN/C6	85	324 SH8	32	516 SP5HYB-S	79	519/280T	22	870 C	89	1651	81	
235 1/2 M/C16	99	324 STX/S7	33	516 SP6A-P	12	519/285A1	22	871 C	89	1785 B	91	
235 3/4 M/D7	99	333 K/S8	45	516 SP6I-P	12	519/285B2	22	871 D	89	1881 S22	81	
236 K 1/2	84	341 SH33	64	516 SP6NV	8	519/285KA1	22	884 C/S6	89	1950 C3	88	
236 K 1/4	84	367 SE6	68	516 SP6SV	10	519/294	22	885 F	89	1950 C6	88	
236 K/C13	84	372 SE6	69	516 SP6UD-796	15	519/322H	22	889 LTE	77	<b>2000</b>		
236 KE 1/2	84	374 N	69	516 SP6UD-894	15	519/322STX	22	889 RD	76	2000 A	91	
236 KE 1/4	84	376	69	516 SP6V	8	519/324H	22	889 RP	77	2550 A	88	
236 KE/C18	84	382	68	516 SP6XLM	14	519/324TX	22	889 RT	77	2550 B	88	
237 1/2 AK	56	382 F	68	516 SP6XLV	10	519/366	22	889 SA	76	2800 S21	85	
237 1/4 AK	56	<b>400</b>		516 SP7NV	8	519/382F	22	889 TR	76	2847 N4	85	
252 N/SR8	52	400 P	90	516 SP7V	8	519/613AEA	22	890 K	81	2847/3	85	
263 RA	87	421	71	516 SPC1	9	519/613BEA	22	<b>900</b>				
263 S16	87	421/120	71	516 SPC2	9	519/613CEA	22	913 PB2 3/8	94	<b>3000</b>		
263 VAG	87	424 A2	70	516 SPCN1	9	519/990A1	22	913 PC2 1/2	94	3500 S1P	75	
		424 A3	70	516 SPCN2	9	532 A	29	920 AN1	96	3781 A	91	
		424 C2	70	519 M 091A	23	532 C	29	921 A4	96	3781 C	91	
		424 N4	70	519 M 127N	23	532 D	29	922 B1	97	3781 D	91	
		425 TPMS	83	519 M 150AX	23	<b>600</b>			922 B2	3781 E	91	
		426 B/S5	90	519 M 276	23	601 1/2 J22	58	922 BL1	97			
		426 C/S4	90	519 M 280HG	23	601 1/4 J34	58	922 BP1	97			

# SCOPRI LE NOVITÀ 2021



NEW

Arredamento 516 Start  
**Pagina 6**



NEW

Pneumatica  
**Pagina 92**



NEW

Bussole macchina  
**Pagina 98**



NEW

Carrelli  
**Pagina 8**



NEW

Carrelli assortiti  
**Pagina 12**



NEW

Banchi da lavoro  
**Pagina 18**

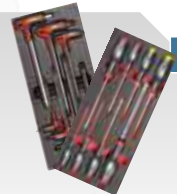

NEW

Assortimenti  
**Pagina 20**



NEW

Valigie manutenzione  
**Pagina 24**



Contenitori trasportabili  
**Pagina 28**



NEW

Giraviti  
**Pagina 32**



Pinze  
**Pagina 36**



NEW

Chiavi maschio e inserti  
**Pagina 40**



Estrattori  
**Pagina 46**



Chiavi di manovra  
**Pagina 49**



NEW

Cricchetti e bussole  
**Pagina 54**



Serraggio controllato  
**Pagina 60**



Idraulica  
**Pagina 62**



Forbici per elettricisti  
**Pagina 63**



Elettrotecnica  
**Pagina 64**



Rivettatrici  
**Pagina 66**



Manutenzione  
**Pagina 68**



NEW

Illuminazione  
**Pagina 76**



NEW

Autoriparazione  
**Pagina 78**



**CERCA GLI ICONIC PRODUCT:**  
i prodotti che fanno la differenza!

## NUOVA LINEA ARREDAMENTO START 516

Una nuova gamma modulare per creare facilmente postazioni di lavoro professionali.



### SEMPLICE ED ESSENZIALE

16 componenti per allestire nel modo in cui preferisci la tua postazione.  
Configurabile in due altezze: 842 mm o 1006 mm (piano di lavoro).

### QUALITA' DELLA GAMMA START

Design e materiali della gamma di carrelli portautensili  
USAG START 516.

Componenti forniti montati e pronti per l'allestimento.

### COMPATIBILE CON LA MODULARITA' USAG

I cassetti sono compatibili con il sistema di moduli in spugna  
o termoformato presenti a Catalogo.



## CONFIGURATORE ONLINE



[start516.usag.it](http://start516.usag.it)



**Il configuratore online ti aiuta a realizzare in modo semplice  
la tua postazione professionale su misura.**

**Provalo subito: vai su [start516.usag.it](http://start516.usag.it)  
o clicca sul banner nella Home Page del sito usag.it**



## 516 SA/C1

Cod. U05160231



Pianale in legno  
1.450 mm  
516 SAL/1

**Arredamento per officina - pianale in legno**

- Fornita con kit base di 30 ganci 516 SA/K1.

~~€ 1.614,00~~ | **€ 1.149,00**



## 516 SA/CA1

Cod. U05160235



Pianale in acciaio  
1.450 mm  
516 AC/1

**Arredamento per officina - pianale in acciaio**

- Fornita con kit base di 30 ganci 516 SA/K1.

~~€ 1.614,00~~ | **€ 1.149,00**



DESCRIZIONE	ART	PZ
Mobile fisso con 6 cassetti	516 SA/1	1
Mobile fisso con 2 ante	516 SA/2	1
Pannello forato portautensili	516 SA/5	6
Rialzo per mobili	516 SA/11	2
Lampada a LED	516 SA/12	2
Ripiano metallico	516 SA/13	2
Kit di montaggio	516 SA/14	2
Kit di 30 ganci per pannelli	516 SA/K1	1



**Include:  
ganci e lampade LED**



## 516 SA/C2

Cod. U05160232



Pianale in legno  
1.450 mm  
516 SAL/1

**Arredamento per officina - pianale in legno**

- Fornita con kit base di 30 ganci 516 SA/K1.

~~€ 2.498,00~~ | **€ 1.769,00**



## 516 SA/CA2

Cod. U05160236



Pianale in acciaio  
1.450 mm  
516 AC/1

**Arredamento per officina - pianale in acciaio**

- Fornita con kit base di 30 ganci 516 SA/K1.

~~€ 2.498,00~~ | **€ 1.769,00**



DESCRIZIONE	ART	PZ
Mobile fisso con 6 cassetti	516 SA/1	1
Mobile fisso con 2 ante	516 SA/2	1
Armadio a 1 anta	516 SA/3	1
Pensile con anta basculante	516 SA/4	2
Pannello forato portautensili	516 SA/5	3
Pannello forato portautensili con 6 prese SCHUKO	516 SA/6	1
Rialzo per mobili	516 SA/11	3
Lampada a LED	516 SA/12	2
Kit di montaggio	516 SA/14	2
Kit di 30 ganci per pannelli	516 SA/K1	1



**Include:  
ganci, lampade LED  
e presa multipla**

## GURAZIONE IDEALE!



### 516 SA/C3

Cod. U05160233



Pianale in legno  
2.175 mm  
516 SAL/2

**Arredamento per officina - pianale in legno**

- Fornita con kit base di 30 ganci 516 SA/K1.

~~€ 3.410,00~~ | **€ 2.399,00**



### 516 SA/CA3

Cod. U05160237



Pianale in acciaio  
2.175 mm  
516 AC/2

**Arredamento per officina - pianale in acciaio**

- Fornita con kit base di 30 ganci 516 SA/K1.

~~€ 3.410,00~~ | **€ 2.399,00**

**NEW**

**Include:  
ganci, lampade LED  
e presa multipla**



DESCRIZIONE	ART	PZ
Mobile fisso con 6 cassetti	516 SA/1	1
Mobile fisso con 2 ante	516 SA/2	1
Armadio a 1 anta	516 SA/3	1
Pensile con anta basculante	516 SA/4	3
Pannello forato portautensili	516 SA/5	5
Pannello forato portautensili con 6 prese SCHUKO	516 SA/6	1
Rialzo per mobili	516 SA/11	3
Lampada a LED	516 SA/12	2
Kit di montaggio	516 SA/14	3
Kit di 30 ganci per pannelli	516 SA/K1	1
Carrello - 6 cassetti	516 SA/16	1



### 516 SA/C4

Cod. U05160234



Pianale in legno  
2.175 mm  
516 SAL/2

**Arredamento per officina - pianale in legno**

- Fornita con kit base di 30 ganci 516 SA/K1.

~~€ 1.857,00~~ | **€ 1.319,00**



### 516 SA/CA4

Cod. U05160238



Pianale in acciaio  
2.175 mm  
516 AC/2

**Arredamento per officina - pianale in acciaio**

- Fornita con kit base di 30 ganci 516 SA/K1.

~~€ 1.857,00~~ | **€ 1.319,00**

**NEW**

**Include:  
ganci, lampade LED  
e presa multipla**



DESCRIZIONE	ART	PZ
Mobile fisso con 6 cassetti	516 SA/1	1
Mobile fisso con 2 ante	516 SA/2	1
Pannello forato portautensili	516 SA/5	8
Pannello forato portautensili con 6 prese SCHUKO	516 SA/6	1
Rialzo per mobili	516 SA/11	2
Lampada a LED	516 SA/12	2
Ripiano metallico	516 SA/13	3
Kit di montaggio	516 SA/14	3
Kit di 30 ganci per pannelli	516 SA/K1	1



YouTube

## START 516



Nuovo colore  
disponibile!



Nuovo colore  
disponibile!



7  
CASSETTI

3  
MODULI

**516 SP7V**  
Cod. U05160007



**Carrello START (vuoto)**

- Dimensioni interne cassetti:
  - 5 cassetti 570x420x60 mm.
  - 1 cassetto 570x420x130 mm.
  - 1 cassetto 570x420x200 mm.

~~€ 680,00~~ | **€ 439,00**

**516 SP7NV**  
Cod. U05160012

**NEW**

**Carrello START (vuoto)**

~~€ 680,00~~ | **€ 439,00**

**MANIGLIE  
BASCULANTI IN ABS**



6  
CASSETTI

3  
MODULI

**516 SP6V**  
Cod. U05160006



**Carrello START (vuoto)**

- Dimensioni interne cassetti:
  - 3 cassetti 570x420x60 mm.
  - 2 cassetti 570x420x130 mm.
  - 1 cassetto 570x420x200 mm.

~~€ 597,00~~ | **€ 399,00**

**516 SP6NV**  
Cod. U05160008

**NEW**

**Carrello START (vuoto)**

~~€ 597,00~~ | **€ 399,00**



### RISPARMIA IL TUO TEMPO

Tutti i carrelli a cassetteria USAG sono subito pronti all'uso, perchè forniti con le ruote già montate alla struttura.





1000 kg



ACCIAIO

6

CASSETTI

3

MODULI

## 516 SPC2

Cod. U05160021



Banco da lavoro START con piano in acciaio

- Dimensioni interne cassetti:
  - 3 cassetti 570x420x60 mm.
  - 2 cassetti 570x420x130 mm.
  - 1 cassetto 570x420x200 mm.

€ 1.132,00 | € 759,00

Nuovo colore  
disponibile!



2000 mm

## 516 SPCN2 **NEW**

Cod. U05160023

Banco da lavoro START con piano in acciaio

€ 1.132,00 | € 759,00

## Piano in acciaio zincato

Trattato anticorrosione e con bordi anticaduta da 37 mm.

1000 kg



LEGNO

6

CASSETTI

3

MODULI

## 516 SPC1

Cod. U05160020



Banco da lavoro START con piano in legno

- Dimensioni interne cassetti:
  - 3 cassetti 570x420x60 mm.
  - 2 cassetti 570x420x130 mm.
  - 1 cassetto 570x420x200 mm.

€ 1.132,00 | € 759,00

Nuovo colore  
disponibile!



2000 mm

## 516 SPCN1 **NEW**

Cod. U05160022

Banco da lavoro START con piano in legno

€ 1.132,00 | € 759,00

## Piano in faggio multistrato

Lo spessore di 40 mm garantisce il top della resistenza.



6  
CASSETTI

4  
MODULI

### 516 SP6XLV

Cod. U05160011

90 kg | mm | 969  
971  
517

#### Carrello Start XL (vuoto)

- Dimensioni interne cassetti:
  - 3 cassetti 760x420x60 mm.
  - 2 cassetti 760x420x130 mm.
  - 1 cassetto 760x420x270 mm.

€ 751,00 | € 495,00

**MANIGLIE  
BASCULANTI IN ABS**



6  
CASSETTI

3  
MODULI

### 516 SP6SV

Cod. U05160013

60 kg | mm | 748  
970  
515

#### Carrello START con sistema antiribaltamento (vuoto)

- Dimensioni interne:
  - 3 cassetti 570x420x60 mm.
  - 2 cassetti 570x420x130 mm.
  - 1 cassetto 570x420x200 mm.

€ 693,00 | € 485,00



**Sistema antiribaltamento**  
che permette di aprire un solo  
cassetto per volta.

## Racing 519



YouTube



**519 R6/3V**  
Cod. U05190414  
Carrello RACING (vuoto)

**519 R6/4V**  
Cod. U05190419  
Carrello RACING (vuoto)

**519 R6/3NV**  
Cod. U05190424  
Carrello RACING (vuoto)

**519 R6/4NV**  
Cod. U05190429  
Carrello RACING (vuoto)

**519 R6/5V**  
Cod. U05190420  
Carrello RACING (vuoto)

- Dimensioni interne:
  - 4 cassetti 570x420x60 mm.
  - 1 cassetto 570x420x130 mm.
  - 1 cassetto 570x420x270 mm.

- Dimensioni interne:
  - 4 cassetti 760x420x60 mm.
  - 1 cassetto 760x420x130 mm.
  - 1 cassetto 760x420x270 mm.

- Dimensioni interne:
  - 3 cassetti 950x420x60 mm.
  - 2 cassetti 950x420x130 mm.
  - 1 cassetto 950x420x200 mm.

€ 990,00 | **€ 693,00**

€ 1.152,00 | **€ 806,00**

€ 1.486,00 | **€ 1.040,00**



**519 R7/3V**  
Cod. U05190415  
Carrello RACING (vuoto)

**519 R8/3V**  
Cod. U05190416  
Carrello RACING (vuoto)

- Dimensioni interne:
  - 5 cassetti 570x420x60 mm.
  - 1 cassetto 570x420x130 mm.
  - 1 cassetto 570x420x200 mm.

- Dimensioni interne:
  - 6 cassetti 570x420x60 mm.
  - 2 cassetti 570x420x130 mm.

€ 1.086,00 | **€ 760,00**

€ 1.181,00 | **€ 827,00**



### RISPARMIA IL TUO TEMPO

Tutti i carrelli a cassettera USAG sono subito pronti all'uso, perchè forniti con le ruote già montate alla struttura.



# Carrelli con assortimento

**NON TROVI IL**  
Vai subito su



**RISPARMI**  
**€ 100**

Rispetto all'acquisto di carrello ed assortimento separati.

**177**  
PEZZI

**516 SP6I-P**  
Cod. U05168020

**Carrello START con assortimento MANUTENZIONE - 4 cassette**

€ 1.778,50 | **€ 909,00**



**RISPARMI**  
**€ 100**

Rispetto all'acquisto di carrello ed assortimento separati.

**151**  
PEZZI

**516 SP6A-P**  
Cod. U05168021

**Carrello START con assortimento AUTORIPARAZIONE - 3 cassette**

€ 1.696,00 | **€ 869,00**

## ASSORTIMENTO MANUTENZIONE

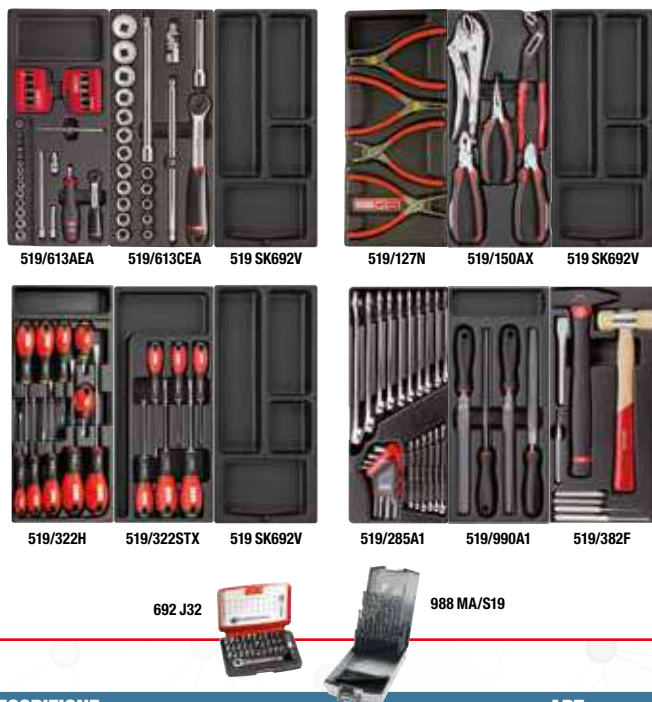

## ASSORTIMENTO AUTORIPARAZIONE

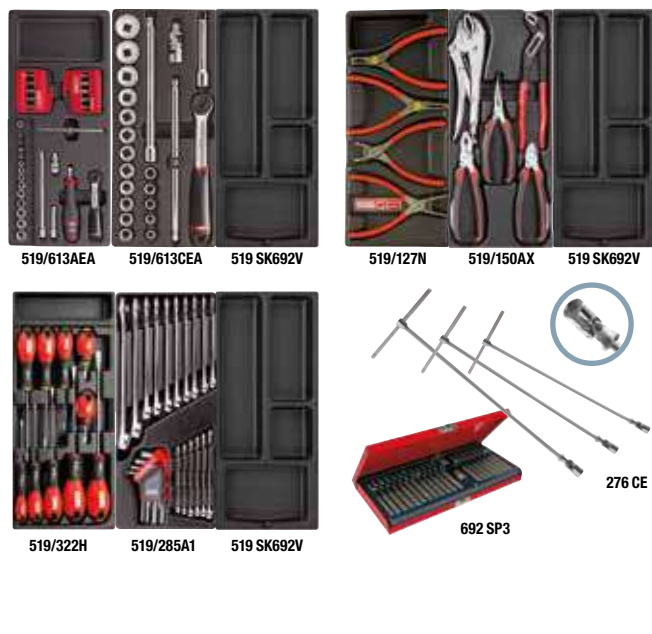

DESCRIZIONE	ART	PZ
Bussole esagonali, cricchetto (237 A 1/4"), accessori 1/4" ed inserti	519/613AEA	42
Bussole esagonali, cricchetto (237 A 1/2") e accessori 1/2"	519/613CEA	22
Pinze per anelli elastici (19-60 mm)	519/127N	4
Pinza universale, pinza regolabile, tronchese, pinza becchi lunghissimi, pinza grip	519/150AX	5
Giraviti a taglio e croce PH	519/322H	10
Giraviti TORX® Tamper Resistant (T10-T15-T20-T-25-T30-T40)	519/322STX	6
Chiavi combinate (6-7-8-9-10-11-12-13-14-15-16-17-18-19-22-24 mm)	519/285A1	25
Lima piatta, mezzotonda, tonda e triangolare	519/990A1	4
Martello, Mazzuola, Scalpelli e cacciapipe	519/382F	8
Assortimento di punte HSS-G	988 MA/S19	19
Assortimento di inserti con cricchetto reversibile	692 J32	32

DESCRIZIONE	ART	PZ
Bussole esagonali, cricchetto (237 A 1/4"), accessori 1/4" ed inserti	519/613AEA	42
Bussole esagonali, cricchetto (237 A 1/2") e accessori 1/2"	519/613CEA	22
Pinze per anelli elastici (19-60 mm)	519/127N	4
Pinza universale, pinza regolabile, tronchese, pinza becchi lunghissimi, pinza grip	519/150AX	5
Giraviti a taglio e croce PH	519/322H	10
Chiavi combinate (6-7-8-9-10-11-12-13-14-15-16-17-18-19-22-24 mm)	519/285A1	25
Assortimento di inserti RIBE con foro - XZN - TORX® Tamper Resistant	692 SP3	40
Chiavi a T snodate con bocca esagonale (10,13,17 mm)	276 CE	3

## TUO ASSORTIMENTO IDEALE?

kitplanner.usag.it e realizzalo!



**RISPARMI**  
**€ 230**

Rispetto all'acquisto di carrello ed assortimento separati.



**RISPARMI**  
**€ 230**

Rispetto all'acquisto di carrello ed assortimento separati.

**157**  
PEZZI

**519 R6/3I-S**  
Cod. U05198022

Carrello RACING con assortimento  
MANUTENZIONE - 3 cassette

~~€ 2.047,50~~ | **€ 1.129,00**

**149**  
PEZZI

**519 R6/3A-S**  
Cod. U05198023

Carrello RACING con assortimento  
AUTORIPARAZIONE - 3 cassette

~~€ 2.149,50~~ | **€ 1.069,00**

### ASSORTIMENTO MANUTENZIONE



### ASSORTIMENTO AUTORIPARAZIONE

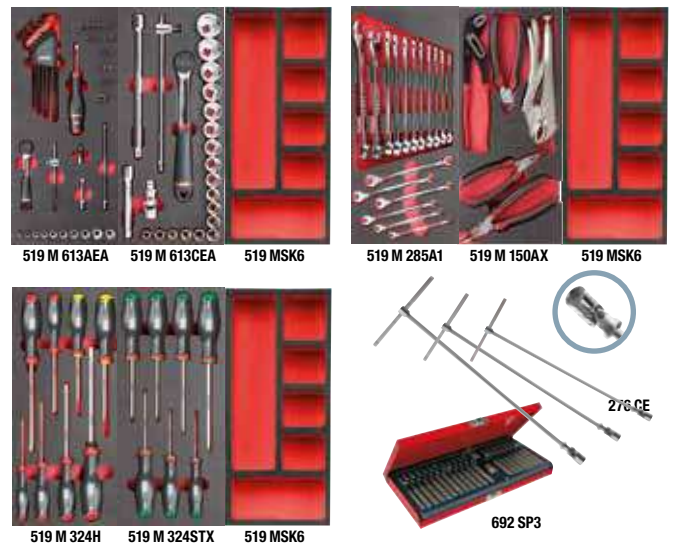

DESCRIZIONE	ART	PZ
Bussole esagonali, cricchetto (237 A 1/4"), accessori 1/4" ed inserti	519 M 613AEA	46
Bussole esagonali, cricchetto (237 A 1/2") e accessori 1/2"	519 M 613CEA	23
Chiavi combinate (6-7-8-9-10-11-12-13-14-15-16-17-18-19-22-24 mm)	519 M 285A1	17
Pinza universale, pinza regolabile, tronchese, pinza becchi lunghissimi, pinza grip	519 M 150AX	5
Giraviti a taglio e croce PH	519 M 324H	8
Giraviti TORX® Tamper Resistant (T10-T15-T20-T25-T30-T40)	519 M 324STX	7
Assortimento di punte HSS-G	988 MA/S19	19
Assortimento di inserti con cricchetto reversibile	692 J32	32

DESCRIZIONE	ART	PZ
Bussole esagonali, cricchetto (237 A 1/4"), accessori 1/4" ed inserti	519 M 613AEA	46
Bussole esagonali, cricchetto (237 A 1/2") e accessori 1/2"	519 M 613CEA	23
Chiavi combinate (6-7-8-9-10-11-12-13-14-15-16-17-18-19-22-24 mm)	519 M 285A1	17
Pinza universale, pinza regolabile, tronchese, pinza becchi lunghissimi, pinza grip	519 M 150AX	5
Giraviti a taglio e croce PH	519 M 324H	8
Giraviti TORX® Tamper Resistant (T10-T15-T20-T25-T30-T40)	519 M 324STX	7
Assortimento di inserti RIBE con foro - XZN - TORX® Tamper Resistant	692 SP3	40
Chiavi a T snodate con bocca esagonale (10,13,17 mm)	276 CE	3

**Vuoi solo l'assortimento? Vai a pagina 20**

**NON TROVI IL**  
Vai subito su



**RISPARMI**  
**€ 200**

Rispetto all'acquisto di carrello ed assortimento separati.

**318**  
PEZZI

**516 SP6XLM**

Cod. U05160111

Carrello **START XL** con assortimento **MANUTENZIONE - 4 cassette**

~~€ 3.149,00~~ | **€ 1.619,00**



**NEW**



**RISPARMI**  
**€ 300**

Rispetto all'acquisto di carrello ed assortimento separati.

**318**  
PEZZI

**519 R8/3M-S**

Cod. U05198024

Carrello **RACING** con assortimento **MANUTENZIONE - 6 cassette**

~~€ 3.620,00~~ | **€ 1.849,00**



## ASSORTIMENTO MANUTENZIONE



519 M 612CLA

519 M 613BEA

519 M 613AEA



519 M 285KA

519 M 285A1

519 M 285A2

519 M 233C24

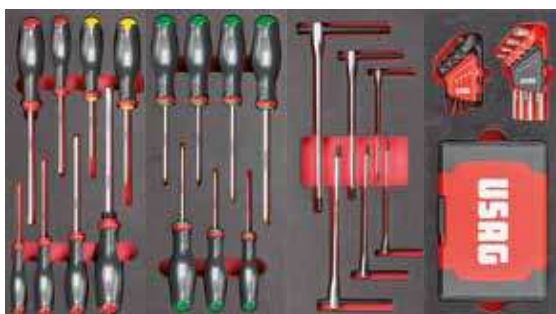

519 M 324H

519 M 324STX

519 M 280TK

519 M 280N1



519 M 127N

519 M 150AX

519 M 382F

519 M 990A5MD

DESCRIZIONE	ART	PZ
Bussole esagonali, cricchetto (237 A 1/4"), accessori 1/4" ed inserti	519 M 613AEA	46
Bussole esagonali, cricchetto (237 A 3/8") e accessori 3/8"	519 M 613BEA	20
Bussole poligonali, cricchetto (237 A 1/2") e accessori 1/2"	519 M 612CLA	35
Chiavi combinate (6-7-8-9-10-11-12-13-14-15-16-17-18-19-22-24 mm)	519 M 285A1	17
Chiavi combinate (27-29-30-32-34 mm)	519 M 285A2	5
Chiavi combinate a cricchetto reversibile (8-9-10-11-12-13-14-15-16-17-18-19-mm)	519 M 285KA	12
Chiavi a bussola TORX® e con inserto TORX®, XZN, esagonale, Ribe	519 M 233 C24	24
Giraviti a taglio e croce PH	519 M 324H	8

DESCRIZIONE	ART	PZ
Giraviti TORX® Tamper Resistant (T10-T15-T20-T25-T30-T40)	519 M 324STX	7
Chiavi maschio a T con traversino scorrevole (2,5-3-4-5- 6-8 mm)	519 M 280TK	6
Cassetta inserti assortita e chiavi maschio esagonali - TORX®	519 M 280N1	117
Pinze per anelli elastici interni ed esterni 19÷60	519 M 127N	4
Pinza universale, pinza regolabile, tronchese, pinza becchi lunghissimi, pinza grip	519 M 150AX	5
Lime a taglio mezzodolce	519 M 990A5MD	5
Martello per meccanici, mazzuola, cacciaspine, scalpello e bulino	519 M 382F	7

## TUO ASSORTIMENTO IDEALE? kitplanner.usag.it e realizzalo!



Incluso  
trapano  
avvitatore

**INSIEME  
UNICI**

**223**  
PEZZI

**516 SP6UD-796**

Cod. U05161796W

Carrello START con assortimento  
MANUTENZIONE - 4 cassetti



~~€ 2.164,04~~ | **€ 999,00**



Incluso  
avvitatore  
ad impulsi

**INSIEME  
UNICI**

**122**  
PEZZI

**516 SP6UD-894**

Cod. U05161894W

Carrello START con assortimento  
AUTORIPARAZIONE - 4 cassetti



~~€ 2.408,43~~ | **€ 999,00**

### ASSORTIMENTO MANUTENZIONE



519 M 613AEA 519 M 613CEA 519 MSK6



519 M 324H 519 M 324STX 519 MSK6



519 M 285A1 519 M 150AX 519 MSK6



519 M 280N1

**18V XR**

Alloggiamenti liberi  
per 2<sup>a</sup> e 3<sup>a</sup> batteria  **DCD796**  
(1 batteria inclusa)

### ASSORTIMENTO AUTORIPARAZIONE



519 M 613AEA 519 M 613CEA 519 MSK6



519 M 324H 519 M 324STX 519 MSK6



519 M 285A1 519 M 150AX 519 MSK6



519 M 236K

**18V XR**

Alloggiamenti liberi  
per 2<sup>a</sup> e 3<sup>a</sup> batteria  **DCF894**  
(1 batteria inclusa)

DESCRIZIONE	ART	PZ
Bussole esagonali, cricchetto (237 A 1/4"), accessori 1/4" ed inserti	519 M 613AEA	46
Bussole esagonali, cricchetto (237 A 1/2") e accessori 1/2"	519 M 613CEA	23
Chiavi combinate (6-7-8-9-10-11-12-13-14-15-16-17-18-19-22-24 mm)	519 M 285A1	17
Pinza universale, pinza regolabile, tronchese, pinza becchi lunghissimi, pinza grip	519 M 150AX	5
Giraviti a taglio e croce PH	519 M 324H	7
Giraviti TORX® Tamper Resistant (T10-T15-T20-T25-T30-T40)	519 M 324STX	8
Cassetta inserti assortita e chiavi maschio esagonali - TORX®	519 M 280N1	117
Caricabatterie universale XR Litio	DCB115	1
Trapano avvitatore con percussione	DCD796	1

DESCRIZIONE	ART	PZ
Bussole esagonali, cricchetto (237 A 1/4"), accessori 1/4" ed inserti	519 M 613AEA	46
Bussole esagonali, cricchetto (237 A 1/2") e accessori 1/2"	519 M 613CEA	23
Chiavi combinate (6-7-8-9-10-11-12-13-14-15-16-17-18-19-22-24 mm)	519 M 285A1	17
Pinza universale, pinza regolabile, tronchese, pinza becchi lunghissimi, pinza grip	519 M 150AX	5
Giraviti a taglio e croce PH	519 M 324H	7
Giraviti TORX® Tamper Resistant (T10-T15-T20-T25-T30-T40)	519 M 324STX	8
Cassetta inserti assortita e chiavi maschio esagonali - TORX®	519 M 280N1	117
Caricabatterie universale XR Litio	DCB115	1
Avvitatore ad impulsi 1/2" con batteria	DCF894	1



**6**  
CASSETTI

**3**  
MODULI

## 519 R6/3V FULL

Cod. U05191414

**Carrello RACING - Full optional (vuoto)**

- Dimensioni interne:
  - 4 cassetti 570x420x60 mm.
  - 1 cassetto 570x420x130 mm.
  - 1 cassetto 570x420x270 mm.

€ 1.475,50 | **€ 793,00**

### COMPLETO DI:

- Pannello superiore.
- Piano appoggio pieghevole.
- Portarotolo.
- Portaflaconi (x2).

**RISPARMI**  
**€ 240**

Rispetto all'acquisto di carrello ed accessori separati.

**NEW**

86 kg | 774 mm | 1.400 mm | 546 mm

## ACCESSORI CARRELLI



### 519 RA1

Cod. U05190207

**Portarifiuti**  
per Racing, Start, Booster e Bull.

€ 88,00 | **€ 62,00**



### 519 RA2

Cod. U05190208

**Portadocumenti**  
per Racing, Start, Booster e Bull.

€ 48,80 | **€ 34,20**



### 519 RA3N

Cod. U05190212

**Pannello superiore**  
per Racing (3 moduli).

€ 138,00 | **€ 97,00**

**NEW**



### 519 RA4

Cod. U05190210

**Portarotolo**  
per Racing, Start, Booster e Bull.

€ 53,50 | **€ 37,50**



### 519 RA5

Cod. U05190211

**Portaflaconi**  
per Racing, Start, Booster e Bull.

€ 77,50 | **€ 54,50**



### 519 RA6

Cod. U05190217

**Piano appoggio pieghevole**  
per Racing.

€ 139,00 | **€ 97,50**



### 519 RA8

Cod. U05190219

**Supporto per documenti**  
per Racing.

€ 55,50 | **€ 38,90**



### 519 RA9

Cod. U05190218

**Piano in legno per morsa**  
per Racing.

€ 139,00 | **€ 97,50**





1100 kg

6 CASSETTI 3 MODULI

94 kg mm 1154 1000 546

## 513 B6V

Cod. U05130096

### Carrello BOOSTER (vuoto)

- Dimensioni interne:
  - 4 cassetti 570x420x60 mm.
  - 1 cassetto 570x420x130 mm.
  - 1 cassetto 570x420x270 mm.
- Vano laterale: 380x400x720 mm.



~~€ 1.485,00~~ | € 1.040,00



200 kg

3 RIPIANI

18 kg mm 750 950 450

## 504 S

Cod. U05040003

### Carrello multiuso

- Ripiani protetti con materiale plastico ad alta resistenza.
- Maniglia in acciaio per una maggiore manovrabilità.
- Due ruote pivotanti (Ø 100 mm) e due ruote fisse (Ø 100 mm).
- Fornito smontato.

~~€ 166,00~~ | € 122,00



1000 kg

6 CASSETTI 3 MODULI

128 kg mm 1.212 1000 670

## 514 B6V

Cod. U05140001

### Banco da lavoro mobile BULL (vuoto)

- Piano di lavoro in legno multistrato.
- Portata massima cassetti: 20 kg.
- Vano laterale: 380x704x524 mm.
- Dimensioni interne:
  - 3 cassetti 570x420x60 mm.
  - 2 cassetti 570x420x130 mm.
  - 1 cassetto 570x420x200 mm.

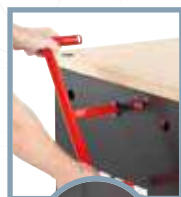

~~€ 1.888,00~~ | € 1.322,00



45 kg mm 720 1.000 280

2 CASSETTI



## 502 R2V

Cod. U05020003

### Armadio vuoto - 2 cassetti

- Pannelli forati interni.
- Apertura a 180° delle ante.
- Cassetto ad estrazione totale.
- Guide telescopiche a sfera.
- Maniglia cassetto in alluminio anodizzato.
- Chiusura a serratura centralizzata.
- Possibilità di ancoraggio a parete o posizionamento su carrelli Racing 519R a 3 moduli (con kit tubi di montaggio U50100193).
- Ante verniciate colore rosso RAL 3020.
- Ganci e supporti non inclusi.
- Dimensioni interne cassetti: 569x210x60 mm.

**ANTE CON DOPPIO PANNELLO**

~~€ 939,00~~ | € 657,00



ACCIAIO

NEW

## 506 BA

### Banco da lavoro con piano in acciaio

- Piano in lamiera d'acciaio zincata (spessore 2,5 mm) con bordi anticaduta altezza 37 mm.
- Ripiano inferiore d'appoggio incluso.
- Predisposizione per il fissaggio al pavimento.
- Struttura in lamiera d'acciaio verniciata, colore nero RAL 9004.
- 4 montanti per le lunghezze 1 m e 1,5 m.
- 6 montanti per la lunghezza 2 m.
- Possibilità di montare il cassetto 506 U130.

CODICE	L (mm)	P (mm)	H (mm)	📏	
U05060014	1.000	700	850	50 kg	€ 237,00   € 166,00
U05060015	1.500	700	850	63 kg	€ 336,00   € 235,00
U05060016	2.000	700	850	85 kg	€ 420,00   € 294,00



LEGNO

NEW

## 506 BL

### Banco da lavoro con piano in legno

- Piano in legno multistrato (spessore 40 mm) integrato nella struttura.
- Ripiano inferiore d'appoggio incluso.
- Predisposizione per il fissaggio al pavimento.
- Struttura in lamiera d'acciaio verniciata, colore nero RAL 9004.
- 4 montanti per le lunghezze 1 m e 1,5 m.
- 6 montanti per la lunghezza 2 m.
- Possibilità di montare il cassetto 506 U130.

CODICE	L (mm)	P (mm)	H (mm)	📏	
U05060004	1.000	700	850	55 kg	€ 340,00   € 238,00
U05060005	1.500	700	850	69 kg	€ 459,00   € 321,00
U05060006	2.000	700	850	93 kg	€ 550,00   € 385,00

### Piano in faggio multistrato

Lo spessore di 40 mm garantisce il top della resistenza.

### Piano in acciaio zincato

Trattato anticorrosione e con bordi anticaduta da 37 mm.

**NEW**

**ACCIAIO**

**2 CASSETTI**

**2000 kg**



106 kg | 2.000 mm | 850 mm | 700 mm

## 506 BAC/2000

**Cod. U05060034**

**Banco da lavoro con piano in acciaio**

- Piano in lamiera d'acciaio zincata (spessore 2,5) con bordi anticaduta altezza 37 mm.
- Ripiano inferiore d'appoggio incluso.
- Predisposizione per il fissaggio al pavimento.
- Struttura in lamiera d'acciaio verniciata, colore nero RAL 9004.
- 6 montanti.
- 2 cassetti con serratura montati su guide telescopiche, colore rosso RAL 3020.
- Dimensione interna cassetti: 570x420x175 mm.

~~€ 636,00~~ | **€ 439,00**

**NEW**

**LEGNO**

**2 CASSETTI**

**2000 kg**



109 kg | 2.000 mm | 850 mm | 700 mm

## 506 BLC/2000

**Cod. U05060024**

**Banco da lavoro con piano in legno**

- Piano in legno multistrato (spessore 40 mm).
- Ripiano inferiore d'appoggio incluso.
- Predisposizione per il fissaggio al pavimento.
- Struttura in lamiera d'acciaio verniciata, colore nero RAL 9004.
- 6 montanti.
- 2 cassetti con serratura montati su guide telescopiche, colore rosso RAL 3020.
- Dimensione interna cassetti: 570x420x175 mm.

~~€ 780,00~~ | **€ 546,00**

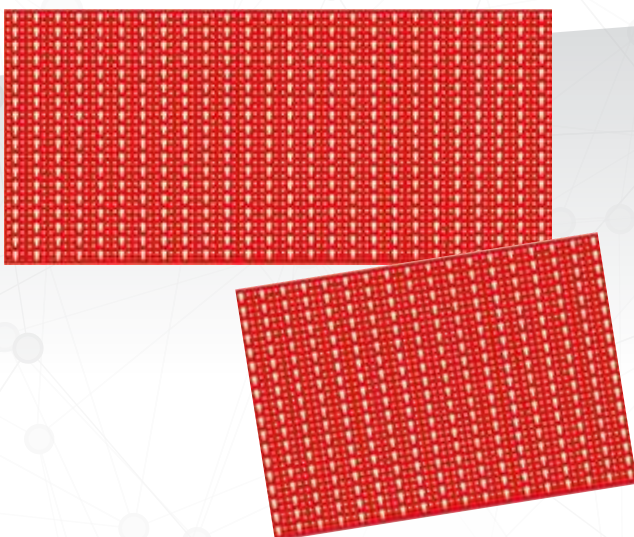

## 501 P

**Pannelli forati**

- Diametro fori 5 mm.
- Lamiera di acciaio, spessore 1,2 mm.
- Esecuzione verniciata colore rosso RAL 3020.
- Utilizzabile con ganci serie 552÷559.

CODICE	L (mm)	H (mm)	kg	€
U05010103Q	1.000	800	9,5 kg	€ 90,50   <b>€ 63,50</b>
U05010104Q	1.500	800	13,5 kg	€ 152,00   <b>€ 106,00</b>
U05010105Q	2.000	800	17,5 kg	€ 174,00   <b>€ 122,00</b>

## MODULI IN SPUGNA BICOLORE



519 M 613AEA 519 M 613CEA 519 MSK6



519 M 285A1 519 M 150AX 519 MSK6



519 M 324H 519 M 324STX 519 MSK6



988 MA/S19

692 J32

157  
PEZZI

### 495 I-SP

Cod. U04950622

Assortimento **INDUSTRIA** - 3 cassetti



DESCRIZIONE	ART	PZ
Bussole esagonali, cricchetto (237 A 1/4"), accessori 1/4" ed inserti	519 M 613AEA	46
Bussole esagonali, cricchetto (237 A 1/2") e accessori 1/2"	519 M 613CEA	23
Chiavi combinate (6-7-8-9-10-11-12-13-14-15-16-17-18-19-22-24 mm)	519 M 285A1	17
Pinza universale, pinza regolabile, tronchese, pinza becchi lunghissimi, pinza grip	519 M 150AX	5
Giraviti a taglio e croce PH	519 M 324H	8
Giraviti TORX® Tamper Resistant (T10-T15-T20-T25-T30-T40)	519 M 324STX	7
Assortimento di punte HSS-G	988 MA/S19	19
Assortimento di inserti con cricchetto reversibile	692 J32	32

~~€ 1.057,50~~ | € 666,00



519 M 613AEA 519 M 613CEA 519 MSK6



519 M 285A1 519 M 150AX 519 MSK6



519 M 324H 519 M 324STX 519 MSK6



276 CE

692 SP3

149  
PEZZI

### 495 A-SP

Cod. U04950623

Assortimento **AUTORIPARAZIONE** - 3 cassetti



DESCRIZIONE	ART	PZ
Bussole esagonali, cricchetto (237 A 1/4"), accessori 1/4" ed inserti	519 M 613AEA	46
Bussole esagonali, cricchetto (237 A 1/2") e accessori 1/2"	519 M 613CEA	23
Chiavi combinate (6-7-8-9-10-11-12-13-14-15-16-17-18-19-22-24 mm)	519 M 285A1	17
Pinza universale, pinza regolabile, tronchese, pinza becchi lunghissimi, pinza grip	519 M 150AX	5
Giraviti a taglio e croce PH	519 M 324H	8
Giraviti TORX® Tamper Resistant (T10-T15-T20-T25-T30-T40)	519 M 324STX	7
Assortimento di inserti RIBE con foro - XZN - TORX® Tamper Resistant	692 SP3	40
Chiavi a T snodate con bocca esagonale (10,13,17 mm)	276 CE	3

~~€ 1.159,50~~ | € 606,00

## ASSORTIMENTO PER CARRELLI 4 MODULI



519 M 612CLA 519 M 613BEA 519 M 613AEA



519 M 285KA 519 M 285A1 519 M 285A2 519 M 233C24

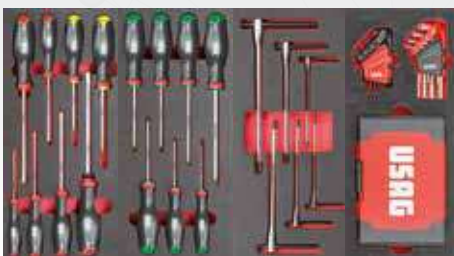

519 M 324H 519 M 324STX 519 M 280TK 519 M 280N1



519 M 127N 519 M 150AX 519 M 382F 519 M 990A5MD

318  
PEZZI

### 495 MA

Cod. U04950023

Assortimento **ANUTENZIONE**  
4 cassetti

~~€ 2.398,00~~ | € 1.324,00

## MODULI IN PLASTICA



519/613AEA 519/613CEA 519 SK692V 519/127N 519/150AX 519 SK692V



519/322H 519/322STX 519 SK692V 519/285A1 519/990A1 519/382F

692 J32



988 MA/S19



519/613AEA 519/613CEA 519 SK692V 519/127N 519/150AX 519 SK692V



519/322H 519/285A1 519 SK692V

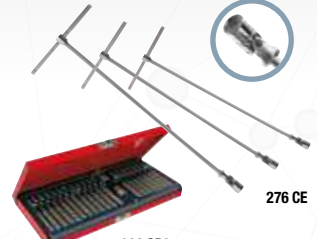

276 CE

692 SP3

177  
PEZZI

### 495 I-PL Cod. U04950620

#### Assortimento INDUSTRIA - 4 cassette



DESCRIZIONE	ART	PZ
Bussole esagonali, cricchetto (237 A 1/4"), accessori 1/4" ed inserti	519/613AEA	42
Bussole esagonali, cricchetto (237 A 1/2") e accessori 1/2"	519/613CEA	22
Pinze per anelli elastici (19-60 mm)	519/127N	4
Pinza universale, pinza regolabile, tronchese, pinza becchi lunghissimi, pinza grip	519/150AX	5
Giraviti a taglio e croce PH	519/322H	10
Giraviti TORX® Tamper Resistant (T10-T15-T20-T25-T30-T40)	519/322STX	6
Chiavi combinate (6-7-8-9-10-11-12-13-14-15-16-17-18-19-22-24 mm)	519/285A1	25
Lima piatta, mezzotonda, tonda e triangolare	519/990A1	4
Martello, Mazzuola, Scalpelli e cacciaspine	519/382F	8
Assortimento di punte HSS-G	988 MA/S19	19
Assortimento di inserti con cricchetto reversibile	692 J32	32

~~€ 1.153,00~~ | € 610,00

151  
PEZZI

### 495 A-PL Cod. U04950621

#### Assortimento AUTORIPARAZIONE - 4 cassette



DESCRIZIONE	ART	PZ
Bussole esagonali, cricchetto (237 A 1/4"), accessori 1/4" ed inserti	519/613AEA	42
Bussole esagonali, cricchetto (237 A 1/2") e accessori 1/2"	519/613CEA	22
Pinze per anelli elastici (19-60 mm)	519/127N	4
Pinza universale, pinza regolabile, tronchese, pinza becchi lunghissimi, pinza grip	519/150AX	5
Giraviti a taglio e croce PH	519/322H	10
Chiavi combinate (8 6-7-8-9-10-11-12-13-14-15-16-17-18-19-22-24 mm)	519/285A1	25
Assortimento di inserti RIBE con foro - XZN - TORX® Tamper Resistant	692 SP3	40
Chiavi a T snodate con bocca esagonale (10,13,17 mm)	276 CE	3

~~€ 1.070,00~~ | € 570,00

DESCRIZIONE	ART	PZ
Bussole esagonali, cricchetto (237 A 1/4"), accessori 1/4" ed inserti	519 M 613AEA	46
Bussole esagonali, cricchetto (237 A 3/8") e accessori 3/8"	519 M 613BEA	20
Bussole esagonali, cricchetto (237 A 1/2") e accessori 1/2"	519 M 612CLA	35
Chiavi combinate (6-7-8-9-10-11-12-13-14-15-16-17-18-19-22-24 mm)	519 M 285A1	17
Chiavi combinate (27-29-30-32-34 mm)	519 M 285A2	5
Chiavi combinate a cricchetto reversibile (8-9-10-11-12-13-14-15-16-17-18-19 mm)	519 M 285KA	12
Chiavi a bussola TORX® e con inserto TORX®, XZN, esagonale, Ribe	519 M 233 C24	24
Giraviti a taglio e croce PH	519 M 324H	8
Giraviti TORX® Tamper Resistant (T10-T15-T20-T25-T30-T40)	519 M 324STX	7
Chiavi maschio a T con traversino scorrevole 2,5-8 mm	519 M 280TK	6
Cassetta inserti assortita e chiavi maschio esagonali - TORX®	519 M 280N1	117
Pinze per anelli elastici interni ed esterni 19-60	519 M 127N	4
Pinza universale, pinza regolabile, tronchese, pinza becchi lunghissimi, pinza grip	519 M 150AX	5
Lime a taglio mezzodolce	519 M 990A5MD	5
Martello per meccanici, mazzuola, cacciaspine, scalpello e bulino	519 M 382F	7



## NON TROVI IL TUO ASSORTIMENTO IDEALE?

Vai subito su  
[kitplanner.usag.it](http://kitplanner.usag.it)  
e realizzalo!

# Moduli in plastica



519/127N  
Cod.U05190716

4 PEZZI

127 N 19÷60 · 127 PN 19÷60 ·  
128 N 19÷60 · 128 PN 19÷60.

€ 94,50 | € 66,50



519/150AX  
Cod.U05190850

5 PEZZI

133 AX 160 · 134 250 · 150 AX 180 ·  
180 C 250 · 188 AX 160.

€ 140,50 | € 98,50



519/280HG  
Cod.U05191860

7 PEZZI

280 HG 3-4-5-6-7-8-10 mm.

€ 97,50 | € 68,50



519/280HGTS  
Cod.U05191861

7 PEZZI

280 HGTS 3-4-5-6-7-8-10 mm.

€ 106,50 | € 75,00



519/285A1  
Cod.U05190785

25 PEZZI

285 6-7-8-9-10-11-12-13-14-15-16-17-  
18-19-22-24 280 S9 1,5÷10.

€ 155,50 | € 109,00



519/285B2  
Cod.U05190823

4 PEZZI

285 27-29-30-32.

€ 88,50 | € 62,00



519/285KA1  
Cod.U05190788

12 PEZZI

285 KA 8-9-10-11-12-13-14-15-  
16-17-18-19.

€ 209,00 | € 146,00



519/294  
Cod.U05190732

9 PEZZI

204 250 · 294 A 250 · 367 2x110-3x130-  
4x145-5x165-6x180-8x200 · 981 A3.

€ 104,00 | € 73,00



519/322H  
Cod.U05190772

10 PEZZI

322 0,5x3x75-0,8x4x100-1x5,5x125-  
1,2x6,5x150-1,6x8x175 · 322 PH 0x75-1x100-  
2x125 · 322 N 0,8x4x30 · 322 NPH 2x30.

€ 51,50 | € 36,10



519/322STX  
Cod.U05190831

6 PEZZI

322 STX T10-T15-T20-T25-T30-T40.

€ 49,00 | € 34,30



519/324H  
Cod.U05190763

10 PEZZI

324 0,5x3x75-0,8x4x100-1x5,5x125-  
1,2x6,5x150-1,2x8x200 · 324 PH 0x75-1x75-  
2x100 · 324 N 0,8x4x35 · 324 NPH 2x35.

€ 66,50 | € 46,60



519/324TX  
Cod.U05190764

9 PEZZI

324 TX T6x50-T7x50-T8x50-T9x75 · 324 STX  
T10x75-T15x75-T20x100-T25x100-T30x125.

€ 93,70 | € 65,50



519/366  
Cod.U05190740

7 PEZZI

351 200 · 362 125-150 · 364 125 ·  
366 3x125 · 4x150 · 368 4x125.

€ 68,50 | € 48,00



519/382F  
Cod.U05190742

8 PEZZI

362 150 · 367 2x110-3x130-4x145-  
5x165 · 368 4x125 · 376 35 · 382F 500.

€ 86,00 | € 60,50



519/613AEA  
Cod.U05190784

42 PEZZI

235 1/4" EN 4-4,5-5-5,5-6-7-8-9-10-11-12-13-  
14 · 236 1/4" 50-150 · 237 A 1/4" · 240 1/4" ·  
241 1/4" · 243 1/4" · 692 S11 · 692 STX/S11 ·  
684 1/4"-1/4".

€ 178,50 | € 125,00



519/613BEA  
Cod.U05190747

21 PEZZI

235 3/8" E 6-7-8-9-10-11-12-13-14-15-  
16-17-18-19-21-22 · 236 3/8" 125-250 ·  
237 A 3/8" · 240 3/8" N · 241 3/8".

€ 182,50 | € 128,00



519/613CEA  
Cod.U05190750

22 PEZZI

235 1/2" EN 10-11-12-13-14-15-16-  
17-18-19-20-21-22-24-27-30-32 · 236  
1/2" 125-250 · 237 A 1/2" · 240 1/2" N ·  
241 1/2".

€ 219,50 | € 154,00



519/990A1  
Cod.U05190825

4 PEZZI

990 M PA/200 · 990 M PB/200  
990 M PC/200 · 990 M PE/200.

€ 49,50 | € 34,70



8 PEZZI

XXL

519/276  
Cod.U05190725

276 CE 7-8-10-11-13-14-17-19.

€ 250,50 | € 175,00



8 PEZZI

XL

519/280T  
Cod.U05190727

280 T 2-2,5-3-4-5-6-8-10.

€ 134,00 | € 94,00



**CREA IL TUO**  
Questa è solo  
disponib

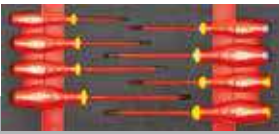

**519 M 091A**  
Cod.U05191016

**8**  
PEZZI

091 0,5x3x75-0,8x4x100-1x5,5x125  
1,2x6,5x150 · 091 PH 1x100-2x125  
· 091 PZ 1x100-2x125.

€ 79,50 | € 56,00



**519 M 280HGTS**  
Cod.U05191946

**7**  
PEZZI

280 HGTS 3-4-5-6-7-8-10 mm.

€ 106,50 | € 75,00



**519 M 285A2**  
Cod.U05190943

**5**  
PEZZI

285 27-29-30-32-34.

€ 128,00 | € 90,00



**519 M 324H**  
Cod.U05190910

**8**  
PEZZI

324 0,5x3x75-0,8x4x100-1x5,5x125-  
1,2x6,5x150 · 324 PH 1x100-2x125  
324 D 0,6x3,5x100 324 E 1,6x8x175.

€ 63,00 | € 44,10



**519 M 613BEA**  
Cod.U05190928

237 A **20**  
PEZZI

235 3/8" E 7-8-9-10-11-12-13-14-15-16-  
17-18-19-21-22 · 236 3/8" 125-250 ·  
237 A 3/8" · 240 3/8" N · 241 3/8".

€ 182,00 | € 127,00



**519 M 127N**  
Cod.U05190937

**4**  
PEZZI

127 N 19÷60 · 127 PN 19÷60 ·  
128 N 19÷60 · 128 PN 19÷60.

€ 99,50 | € 70,00



**519 M 280N1**  
Cod.U05191013

**117**  
PEZZI

280 S9 1,5-2-2,5-3-4-5-6-8-10 · 280 TX/  
S8C T10-T15-T20-T25-T27-T30-T40-T45  
· 692 J100.

€ 114,00 | € 80,00



**519 M 285KA**  
Cod.U05190944

**12**  
PEZZI

285 KA 8-9-10-11-12-13-14-15-  
16-17-18-19.

€ 214,00 | € 150,00



**519 M 150AX**  
Cod.U05190965

**5**  
PEZZI

133 AX 160 · 134 250 · 150 AX 180 ·  
180 C 250 · 188 AX 160.

€ 145,50 | € 102,00



**519 M 280TK**  
Cod.U05190935

**6**  
PEZZI

280 TK 2,5-3-4-5-6-8.

€ 103,50 | € 72,50



**519 M 322H**  
Cod.U05190927

**8**  
PEZZI

322 0,5x3x75-0,8x4x100-1x5,5x125-  
1,2x6,5x150-1,6x8x175 · 322 PH 0x75-  
1x100-2x125.

€ 47,00 | € 32,90



**519 M 280HG**  
Cod.U05191945

**7**  
PEZZI

280 HG 3-4-5-6-7-8-10 mm.

€ 97,50 | € 68,50



**519 M 285A1**  
Cod.U05190921

**17**  
PEZZI

285 6-7-8-9-10-11-12-13-14-15-16-  
17-18-19-21-22-24.

€ 157,00 | € 110,00



**519 M 322STX**  
Cod.U05190929

**6**  
PEZZI

322 STX T10x75-T15x75-T20x100-  
T25x100-T30x125-T40x125.

€ 54,00 | € 37,80



**519 M 324STX**  
Cod.U05190911

**7**  
PEZZI

324 STX T10x75-T15x75-T20x100-  
T25x100-T27x100-T30x125-T40x150.

€ 94,00 | € 66,00



**519 M 382F**  
Cod.U05190926

**7**  
PEZZI

362 175 · 367 2x100-3x130-6x180  
368 3x100 · 376 28 · 382F 500.

€ 105,00 | € 73,50



**519 M 613AEA**  
Cod.U05190940

237 A **46**  
PEZZI

235 1/4" EN 5,5-6-7-8-9-10-11-12-13-14  
· 236 1/4" 50-100 · 237 A 1/4" · 240 1/4"  
· 241 1/4" · 243 1/4" · 280 LTS/S9 · 684  
1/4"-1/4" · 660 0,6-1-1,6 · 660 E 3-4-5-6-  
8 · 660 PH 1-2-3 · 660 PZ 1-2-3 · 660 STX  
T15-T20-T25-T27-T30-T40.

€ 212,00 | € 148,00



**519 M 613CEA**  
Cod.U05190942

237 A **23**  
PEZZI

235 1/2" EN 8-10-11-12-13-14-15-16-  
17-18-19-21-22-23-24-27-30-32 · 236  
1/2" 125-250 · 237 A 1/2" · 240 1/2" N  
· 241 1/2".

€ 230,50 | € 161,00



**519 M 990A5MD**  
Cod.U05191011

**5**  
PEZZI

990 M PA/200 · 990 M PB/200 · 990 M  
PC/200 · 990 M PD/200 · 990 M PE/200.

€ 66,00 | € 46,20

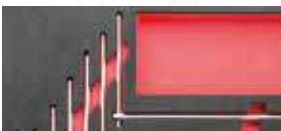

**7**  
PEZZI

**XXL**

**519 M 276**  
Cod.U05190936

276 CE 7-8-10-11-13-17-19.

€ 231,00 | € 162,00

**ASSORTIMENTO IDEALE:**  
una selezione dei 200 moduli  
ili su [kitplanner.usag.it](http://kitplanner.usag.it)

# Valigia per manutenzione

11 kg | 460 mm | 158 mm | 385 mm

## 002 JMA

Cod. U00020011

### Valigia con assortimento per manutenzione

- Valigia con struttura in profilato di Alluminio.
- Doppia cerniera di chiusura in metallo con serratura.
- 3 pannelli portautensili interni con elastici di tenuta.
- Base con interno in mousse bicolore sagomata.

~~€ 619,50~~ | **€ 360,00**



**181**  
PEZZI



**CONTIENE LE PINZE SERIE AX,  
I GIRAVITI 324  
E LA CHIAVE A RULLINO 294 AD!**



DESCRIZIONE	MISURA	PZ.	DESCRIZIONE	MISURA	PZ.
Chiavi a bussola 1/2" con bocca esagonale	10-11-12-13-14-15-16-17-18-19-21-22-24-27-30-32 mm	16	Giravite cercafase		1
Chiavi a bussola 1/4" con bocca esagonale	4-4,5-5-5,5-6-7-8-9-10-11-12-13-14 mm	13	Forbice da elettricista		1
Prolunghe 1/2"	130-250 mm	2	Cutter multiuso		1
Prolunghe 1/4"	55-100 mm	2	Flessometro	3 m	1
Cricchetto reversibile 1/2"		1	Mini seghetto		1
Cricchetto reversibile 1/4"		1	Martello da meccanico	300 g	1
Impugnatura porta bussole 1/4"		1	Inseri ad intaglio	3-4-4,5-5-5,5-6-6,5-7-8	9
Snodo cardanico 1/2"		1	Inseri a croce PHILLIPS®	00-0-1(x2)-2(x2)-3-4	8
Snodo cardanico 1/4"		1	Inseri a croce POZIDRIV-SUPADRIV®	1-2(x2)-3-4	5
Bussola portainseri	1/4-1/4"	1	Inseri esagonali maschio	1,5-2-2,5-3-4-5-5,5-6-7-8 mm	10
Chiavi combinate	8-9-10-11-12-13-14-15-16-17-18-19 mm	12	Inseri esagonali maschio	1/16-5/64-3/32-7/64-1/8-9/64-5/32-3/16-7/32-1/4	10
Chiave a rullino	250 mm	1	Inseri TORX®	T8-T9-T10-T15-T20-T25-T27-T30-T40-T45	10
Giraviti ad intaglio	0,4x2,5x50-0,5x3x75-0,8x4x100-1x5,5x125-1,2x6,5x150-1,6x8x175	6	Inseri TORX® Tamper Resistant	T8-T10-T15-T20-T25-T27-T30-T35-T45	9
Giraviti a croce PHILLIPS®	1x75-2x125	2	Inseri Tri-Wing	1-2-3-4	4
Giraviti a croce POZIDRIV-SUPADRIV®	1x75-2x125	2	Inseri Spanner	4-6-8-10-12	5
Chiavi maschio esagonali	1,5-2-2,5-3-4-5-6-8-10 mm	9	Inseri Torq-set	6-8-10	3
Pinza universale	180 mm	1	Inseri quadrati	0-1-2(x2)-3	5
Pinza regolabile	250 mm	1	Inseri Clutch	1/8-5/32-3/16-1/4-5/16	5
Pinza a becchi mezzotondi	160 mm	1	Inseri per viti con impronta XZN	M5-M6-M8	3
Tronchese a taglio diagonale	160 mm	1	Inseri esagonali maschio con foro	2-2,5-3-4-5-6	6
			Inseri esagonali maschio con foro	5/64-3/32-7/64-1/8-9/64-5/32	6
			Prolunghe magnetiche	1/4"	2



## 002 JTMA

Cod. U00020015

### Valigia trolley con assortimento per manutenzione

- Valigia con struttura in profilato di Alluminio.
- Doppia cerniera di chiusura in metallo con serratura.
- 3 pannelli portautensili interni con elastici di tenuta.
- Base con interno in mousse bicolore sagomata.

~~€ 619,50~~ | **€ 380,00**

**181**  
PEZZI



**RUOTE INTEGRATE  
NELLA STRUTTURA**

11 kg | 470 mm | 200 mm | 370 mm

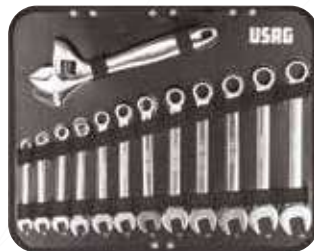

DESCRIZIONE	MISURA	PZ.
Chiavi a bussola 1/2" con bocca esagonale	10-11-12-13-14-15-16-17-18-19-21-22-24-27-30-32 mm	16
Chiavi a bussola 1/4" con bocca esagonale	4-4,5-5-5,5-6-7-8-9-10-11-12-13-14 mm	13
Prolunghe 1/2"	130-250 mm	2
Prolunghe 1/4"	55-100 mm	2
Cricchetto reversibile 1/2"		1
Cricchetto reversibile 1/4"		1
Impugnatura porta bussole 1/4"		1
Snodo cardanico 1/2"		1
Snodo cardanico 1/4"		1
Bussola portainseri	1/4-1/4"	1
Chiavi combinate	8-9-10-11-12-13-14-15-16-17-18-19 mm	12
Chiave a rullino	250 mm	1
Giraviti ad intaglio	0,4x2,5x50-0,5x3x75-0,8x4x100-1x5,5x125-1,2x6,5x150-1,6x8x175	6
Giraviti a croce PHILLIPS®	1x75-2x125	2
Giraviti a croce POZIDRIV-SUPADRIV®	1x75-2x125	2
Chiavi maschio esagonali	1,5-2-2,5-3-4-5-6-8-10 mm	9
Pinza universale	180 mm	1
Pinza regolabile	250 mm	1
Pinza a becchi mezzotondi	160 mm	1
Tronchese a taglio diagonale	160 mm	1
Giravite cercafase		1

DESCRIZIONE	MISURA	PZ.
Forbice da elettricista		1
Cutter multiuso		1
Flessometro	3 m	1
Mini seghetto		1
Martello da meccanico	300 g	1
Inseri ad intaglio	3-4-4,5-5-5,5-6-6,5-7-8	9
Inseri a croce PHILLIPS®	00-0-1(x2)-2(x2)-3-4	8
Inseri a croce POZIDRIV-SUPADRIV®	1-2(x2)-3-4	5
Inseri esagonali maschio	1,5-2-2,5-3-4-5-5,5-6-7-8 mm	10
Inseri esagonali maschio	1/16-5/64-3/32-7/64-1/8-9/64-5/32-3/16-7/32-1/4	10
Inseri TORX®	T8-T9-T10-T15-T20-T25-T27-T30-T40-T45	10
Inseri TORX® Tamper Resistant	T8-T10-T15-T20-T25-T27-T30-T35-T45	9
Inseri Tri-Wing	1-2-3-4	4
Inseri Spanner	4-6-8-10-12	5
Inseri Torq-set	6-8-10	3
Inseri quadrati	0-1-2(x2)-3	5
Inseri Clutch	1/8-5/32-3/16-1/4-5/16	5
Inseri per viti con impronta XZN	M5-M6-M8	3
Inseri esagonali maschio con foro	2-2,5-3-4-5-6	6
Inseri esagonali maschio con foro	5/64-3/32-7/64-1/8-9/64-5/32	6
Prolunghe magnetiche	1/4"	2

**NEW**

## INSIEME UNICI

**002 UDM**

Cod. U00021706W

**Valigia con assortimento per manutenzione**

- Valigia con struttura in profilato di Alluminio.
- Doppia cerniera di chiusura in metallo con serratura.
- 3 pannelli portautensili interni con elastici di tenuta.
- Base con interno in mousse bicolore sagomata.

~~€ 797,00~~ | **€ 399,00**



		← 460
11 kg	mm	↓ 158
		↗ 385



**74**  
UTENSILI



**CONTIENE LE PINZE SERIE AX,  
I GIRAVITI 324  
E LA CHIAVE A RULLINO 294 AD!**



**2 BATTERIE  
INCLUSE**



**12V XR**

**DCD706**

**Trapano avvitatore a percussione**

- Coppia 57Nm.
- 0-425/1500 giri/minuto.
- Mandrino in metallo autoserrante 1-10mm.
- 2 batterie XR 12V 3.0AH.
- Caricabatterie rapido.



**MODELLO  
CON PERCUSSIONE**

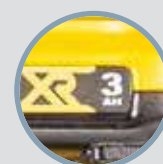

**BATTERIE  
DA 3.0 AH**

# INSIEME UNICI

**NEW**



## 002 UDE

Cod. U00022706W

### Valigia con assortimento per elettricisti

- Valigia con struttura in profilato di Alluminio.
- Doppia cerniera di chiusura in metallo con serratura.
- 3 pannelli portautensili interni con elastici di tenuta.
- Base con interno in mousse bicolore sagomata.

€ 652,00 | **€ 399,00**



**62**  
UTENSILI



**CHIAVI COMBinate  
NON INCLUDE**

11 kg | 460 mm | 158 mm | 385 mm

**CONTIENE LE PINZE ISOLATE SERIE EX,  
I GIRAVITI ISOLATI 091!**



**2 BATTERIE  
INCLUSE**



**12V XR**

## DCD706

### Trapano avvitatore a percussione

- Coppia 57Nm.
- 0-425/1500 giri/minuto.
- Mandrino in metallo autoserrante 1-10mm.
- 2 batterie XR 12V 3.0AH.
- Caricabatterie rapido.



**MODELLO  
CON PERCUSSIONE**



**BATTERIE  
DA 3.0 AH**



Resistente agli urti



Resistente alle alte e basse temperature

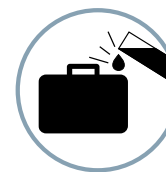

Anti corrosione



MAX  
20 kg

4,7 kg  
465 mm  
352 mm  
215 mm

## 001 RV

Cod. U00010004

### Valigia porta utensili in polipropilene ad alto spessore (vuota)

- Due pannelli interni amovibili con elastici portautensili.
- Vano inferiore con divisori amovibili e regolabili.
- Doppia serratura con chiave.
- Maniglia ergonomica rivestita in gomma.
- 3 cerniere posteriori e doppio braccetto di tenuta coperchio in metallo.
- Gusci in polipropilene ad alto spessore montati su un'intelaiatura di alluminio.
- La struttura garantisce resistenza alle sostanze corrosive, alle basse ed alte temperature ed agli urti anche sugli angoli.

~~€ 253,00~~ | **€ 177,00**



MAX  
20 kg

6 kg  
465 mm  
352 mm  
255 mm

## 001 TRV

Cod. U00010005

### Valigia trolley porta utensili in polipropilene ad alto spessore (vuota)

- Maniglia telescopica in alluminio.
- Ruote con cuscinetto a sfera integrato.

~~€ 373,00~~ | **€ 261,00**



## 641 T

### Cassetta portautensili (vuota)

- In materiale plastico ad alta resistenza.
- 2 scomparti portaminuteria sul coperchio.
- Possibilità di chiusura con lucchetto (non fornito).
- Vassoio interno amovibile.

	CODICE	L (mm)	P (mm)	H (mm)	kg	
A	U06410004	16"	394	220	1,2 kg	<del>€ 19,50</del>   <b>€ 13,70</b>
B	U06410005	19"	486	266	2,1 kg	<del>€ 29,20</del>   <b>€ 20,50</b>
C	U06410006	24"	595	281	2,8 kg	<del>€ 38,90</del>   <b>€ 27,30</b>



Sistema di apertura con una sola mano



Possibilità di chiusura con lucchetto (non fornito)



2 scomparti portaminuteria sul coperchio



## 532

### Baule portautensili (vuoto)

- Apertura ad arresto a 95°.
- Gancio per chiusura a lucchetto.
- Struttura in lamiera di acciaio, spessore 1,2 mm.

	CODICE	L (mm)	P (mm)	H (mm)		
A	U05320005	520	290	290	6,8 kg	€ 113,00   <b>€ 79,50</b>
B	U05320006	650	350	350	12,5 kg	€ 138,00   <b>€ 97,00</b>
C	U05320007	850	350	350	16 kg	€ 140,00   <b>€ 98,00</b>
D	U05320008	1000	400	450	19 kg	€ 181,00   <b>€ 127,00</b>

**5**  
SCOMPARTI



## 646/5V

Cod. U06460201

### Cassetta estensibile (vuota)

- Predisposizione per lucchetto.
- Struttura in lamiera d'acciaio con verniciatura anaforetica.
- Dimensioni interne:
  - vano 447x207x100 mm.
  - scomparti 447x103x52 mm.

~~€ 54,00~~ | **€ 37,80**



**5**  
SCOMPARTI



## 646/5LV

Cod. U06460301

### Cassetta estensibile LUNGA (vuota)

- Predisposizione per lucchetto.
- Struttura in lamiera d'acciaio con verniciatura anaforetica.
- Versione lunga della cassetta 646/5V.
- Dimensioni interne:
  - vano 537x207x100 mm.
  - scomparti 537x103x52 mm.

~~€ 59,00~~ | **€ 41,30**



**8**  
VASCHETTE

## 640 A

Cod. U06400001

### Organizer (vuoto)

- Coperchio trasparente: visibilità istantanea del contenuto.
- 8 vaschette interne amovibili di cui 1 suddivisibile tramite 2 divisori in dotazione.
- Blocco delle vaschette interne tramite chiusura del coperchio.
- Clip esterne di chiusura in materiale plastico.

~~€ 26,10~~ | **€ 18,30**



# Contenitori in tessuto



Cinghia posteriore per fissare la borsa al trolley



8 pratici vani e 6 elastici portautensili

## 007 FTSV

Cod. U00070060

### Borsa portautensili pieghevole (vuota)

- Tessuto ad altissima resistenza.
- 8 pratici e comodi vani portautensili.
- Pannello centrale con elastici portautensili in entrambi i lati.
- Asole porta martello.
- Maniglia superiore con rivestimento in gomma.
- Cinghia posteriore per fissare la borsa al trolley.
- Possibilità di essere utilizzata con tracolla (non inclusa).
- Codice tracolla: U00070001Q.

~~€ 30,30~~ | **€ 21,30**



900 g | 340 mm | 235 mm | 90 mm



Compatibile con

**TSTAK™**

STANLEY: FMST1-71968

DeWALT: DWST1-70705



MAX 12 kg | CAPACITÀ 30 L

3,1 kg | 355 mm | 225 mm | 460 mm



Tasca porta Notebook o documenti

## 007 SV

Cod. U00070004

### Zaino professionale portautensili (vuoto)

- Nylon ad altissima resistenza.
- Cinturino pettorale regolabile.
- Cinghie in vita imbottite.
- Base rigida resistente all'acqua.
- Vano interno portautensili.
- Portadocumenti interno.
- La tasca posteriore può contenere Notebook di dimensioni: L 340 mm - H 240 mm.

~~€ 80,50~~ | **€ 56,50**



MAX 14 kg | CAPACITÀ 50 L

3,5 kg | 350 mm | 500 mm | 200 mm



Tasca porta Notebook o documenti

## 007 TV

Cod. U00070006

### Trolley professionale portautensili (vuoto)

- Dimensioni bagaglio a mano (cabin size).
- Tessuto ad altissima resistenza.
- Pratici e comodi vani interni portautensili.
- Tasca frontale portadocumenti.
- Tasche laterali con cinghie per il trasporto di oggetti lunghi.
- Asta telescopica in alluminio.
- Ruote integrate nella struttura.
- Bretelle posteriori per il trasporto a spalla.
- La tasca posteriore può contenere Notebook di dimensioni L:340 mm - H:240 mm.

~~€ 100,00~~ | **€ 70,00**

YouTube



420 mm

MAX  
11 kg

2,5 kg | 420 mm | 340 mm | 240 mm



Tutta l'attrezzatura a portata di mano

## 007/1V

Cod. U00070001

**Borsa professionale portautensili (vuota)**

- Nylon ad altissima resistenza.
- Base rigida e resistente all'acqua.
- Pratici e comodi vani interni portautensili.
- Due tasche frontali portaminuteria.
- Pratico maniglione in alluminio.
- Ganci interni porta flessometro ed elastici portautensili.
- Mantella di chiusura tramite velcro.

~~€ 66,00~~ | **€ 46,20**



490 mm

MAX  
15 kg

4 kg | 490 mm | 350 mm | 220 mm



Tasca frontale porta seghetto

## 007 V

Cod. U00070002

**Borsa professionale portautensili (vuota)**

- Nylon ad altissima resistenza.
- Base rigida resistente all'acqua.
- Vani interni portautensili e tasca frontale porta seghetto.
- Maniglione in alluminio con impugnatura rivestita.
- Cinghia di trasporto a tracolla.
- Mantella di chiusura con velcro.

~~€ 85,50~~ | **€ 60,00**



MAX  
14 kg



1,8 kg | 460 mm | 160 mm | 350 mm



L'apertura frontale consente un rapido accesso al contenuto.

## 007 RV

Cod. U00070033

**Borsa per utensili e PC (vuota)**

- Tessuto ad altissima resistenza.
- Base rigida rinforzata.
- Può contenere Notebook di dimensioni L:340 mm - H:240 mm.
- 14 tasche, 2 cinghie portautensili e 1 gancio ferma flessometro.
- Tracolla amovibile per un comfort extra nel trasporto.
- Chiusura tramite fibbie a scatto con sgancio rapido.

~~€ 56,50~~ | **€ 39,60**

## GIRAVITI 324 IL TOP DEL MERCATO



### IMPUGNATURA TRIMATERIALE

- 1 Esterno in poliuretano resistente ad oli ed agenti chimici.
- 2 Corpo in poliammide resistente agli sforzi.
- 3 Interno in poliammide ad alta densità per un perfetto accoppiamento alla lama.

### LAMA RINFORZATA

Acciaio al cromo silicio vanadio per la massima resistenza meccanica.



### PUNTA AL TOP

Finitura zincata. Geometria perfetta. Trattamento anti corrosione.

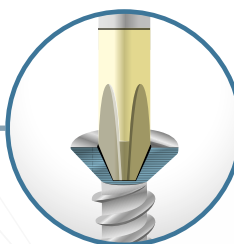

### RIVESTIMENTO SOFT GRIP

Miglior comfort durante l'uso. Maggiore trasmissione della coppia.

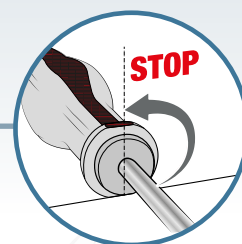

### GEOMETRIA ANTI-ROTOLAMENTO



YouTube



8  
PEZZI



### 324 SH8

Cod. U03240650

Serie di 8 giraviti per viti con intaglio e impronta a croce PHILLIPS®

- 324 D/0,4x2,5x50.
- 324/0,5x3x75-0,8x4x100-1x5,5x125-1,2x6,5x150.
- 324 PH/0x75-1x75-2x100.

€ 42,80 | € 27,50



5  
PEZZI



**NEW**

### 324 SH5

Cod. U03240645

Serie di 5 giraviti per viti con intaglio e impronta a croce PHILLIPS®

- 324/0,8x4x100-1x5,5x125.
- 324 PH/0x75-1x75-2x100.

€ 28,70 | € 18,90





12  
PEZZI



## 324 SH12

Cod. U03240651

Serie di 12 giraviti per viti con intaglio, impronta a croce PHILLIPS® e impronta a croce POZIDRIV® - SUPADRIV®

- 324 D/0,4x2,5x50.
- 324/0,5x3x75-0,8x4x100-1x5,5x125-1,2x6,5x150.
- 324 N/1x5,5x35.
- 324 PH/0x75-1x75-2x100.
- 324 NPH/2x35.
- 324 PZ/1x75-2x100.

~~€ 72,50~~ | € 49,00



7  
PEZZI



## 324 STX/S7

Cod. U03240662

Serie di 7 giraviti con impronta TORX® Tamper Resistant

- 324 STX T10x75-T15x75-T20x100-T25x100-T27x100-T30x125-T40x150.

~~€ 84,00~~ | € 57,00



**Modello  
con lama lunga**



## 324 LPH

Giraviti per viti con impronta a croce PHILLIPS®

- Modello con lama lunga.

CODICE	MISURA	L (mm)	<del>€</del>	€
U03240450	1x250	359	€ 9,65	€ 6,80
U03240451	2x250	370	€ 12,30	€ 8,70
U03240452	2x400	520	€ 14,90	€ 10,50

## GIRAVITI 091 ISOLATI 1000 V

  
**1000 V**  
**EN 60900**

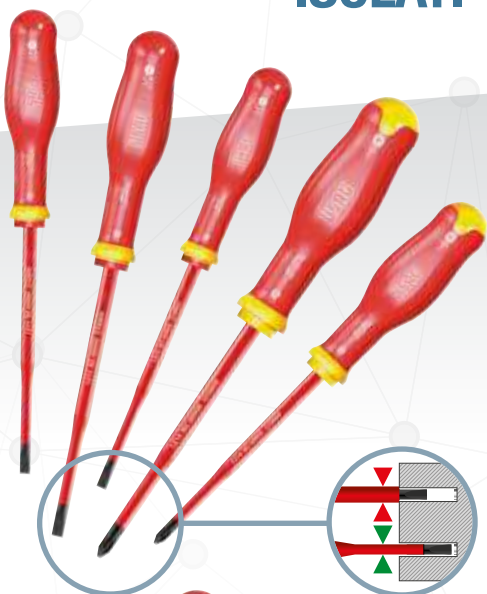

**5**

PEZZI



### 091 D/SH5

Cod. U00910119

Serie di 5 giraviti SLIM per viti con intaglio e per viti con impronta a croce PHILLIPS®

- 091 D/0,6x3,5x100-0,8x4x100-1x5,5x125.
- 091 DPH/1x100-2x125.

~~€ 48,50~~ | **€ 34,00**

**USAG SLIM**

**GUAINA ISOLANTE**

integrata nel diametro della lama

  
**1000 V**  
**EN 60900**



**5**

PEZZI



### 091 SH5

Cod. U00910100

Serie di 5 giraviti per viti con intaglio e per viti con impronta a croce PHILLIPS®

- 091/0,5x3x75-0,8x4x100-1x5,5x125.
- 091 PH/1x100-2x125.

~~€ 39,90~~ | **€ 29,50**

  
**1000 V**  
**EN 60900**



**8**

PEZZI



### 091 SH8

Cod. U00910106

Serie di 8 giraviti per viti con intaglio, per viti con impronta a croce PHILLIPS® e impronta a croce POZIDRIV® - SUPADRIV®

- 091/0,5x3x75-0,8x4x100-1x5,5x125-1,2x6,5x150.
- 091 PH/1x100-2x125.
- 091 PZ/1x100-2x125.

~~€ 68,50~~ | **€ 48,00**

# GIRAVITI 322

## QUALITÀ E CONVENIENZA



7

PEZZI



### 322 SH7

Cod. U03220254

Serie di 7 giraviti per viti con intaglio e impronta a croce PHILLIPS®

- 322//0,4x2x50-0,5x3x75-0,8x4x100-1,5,5x100-1,2x6,5x150.
- 322 PH/1x100-2x125.

~~€ 29,90~~ | **€ 21,00**



10

PEZZI



### 322 SH10

Cod. U03220255

Serie di 10 giraviti per viti con intaglio, impronta a croce PHILLIPS® e impronta a croce POZIDRIV®

- 322/0,4x2x50-0,5x3x75-0,8x4x100-1x5,5x100-1,2x6,5x150.
- 322 PH/0x75-1x100-2x125.
- 322 PZ/1x100-2x125

~~€ 44,50~~ | **€ 31,20**



7

PEZZI



### 322 STX/S7

Cod. U03220263

Serie di 7 giraviti con impronta TORX® Tamper Resistant

- 324 STX T10x75-T15x75-T20x100-T25x100-T27x100-T30x125-T40x150.

~~€ 51,50~~ | **€ 36,10**

## GAMMA PINZE "AX": IL TOP DELLE PERFORMANCE FINITURA CROMATA ED IMPUGNATURE BIMATERIALE



Taglia fino a Ø 2 mm di filo armonico con il 30% in meno di forza rispetto al valore massimo indicato dalle normative europee ISO5749 (tronchesi) - ISO5746 (pinze).

YouTube



**TAGLIENTI TEMPRATI AD INDUZIONE**  
per la massima efficacia nel taglio del filo armonico.

**FULCRO PIÙ VICINO AI TAGLIENTI**  
per il minimo sforzo durante il taglio.

**IMPUGNATURE ERGONOMICHE BIMATERIALE**

IMPUGNATURA USAG



- SFORZO

PRODOTTI SUL MERCATO



+ SFORZO

Minimo sforzo risultante dagli studi sugli sforzi muscolari effettuati dal prestigioso istituto americano US Ergonomics.



2 PEZZI

### 150 AX/SE2

Cod. U01500200

**Assortimento con pinza universale e tronchese a tagliente diagonale**

- Pinza universale 150 AX 180.
- Tronchese a grande effetto a tagliente diagonale 188 AX 160.

~~€ 54,50~~ | **€ 38,20**



3 PEZZI

### 150 AX/SE3

Cod. U01500201

**Assortimento con pinza universale, pinza a becchi mezzotondi diritti e tronchese a tagliente diagonale**

- Pinza universale 150 AX 180.
- Pinza a becchi mezzotondi lunghissimi diritti 133 AX 160.
- Tronchese a grande effetto a tagliente diagonale 188 AX 160.

~~€ 83,50~~ | **€ 58,50**

**CERNIERA  
CHIUSA**



**2  
PEZZI**

## 150 AX/SP2

Cod. U01500202

**Assortimento con pinza universale e pinza regolabile**

- Pinza universale 150 AX 180.
- Pinza regolabile a cerniera chiusa 180 C 250.

~~€ 57,00~~ | **€ 39,90**

## Pinza multifunzione

### PROFILI TONDI

Intaglio ricavato nella dentatura per una presa sicura di barre tonde, anche filettate.



### PROFILI ESAGONALI

Geometria delle ganasce studiata per la presa di un esagono.

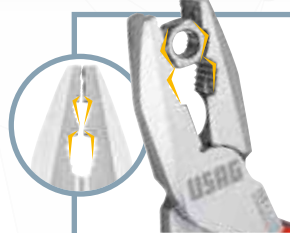

## 155 AX

Cod. U01550001

**Pinza universale multifunzione**

~~€ 51,50~~ | **€ 29,90**



**SISTEMA DI APERTURA  
BREVETTATO**

**CERNIERA  
SOVRAPPOSTA**

MAX Ø  
**110**  
mm



## 135 B

Cod. U01350510

**Pinza regolabile autobloccante a cremagliera con ganasce lunghe**

- Ganasce forgiate.
- Dentatura studiata per una presa perfetta anche su tondo.
- Sistema di apertura brevettato ed integrato nei manici.
- Rullino di regolazione della presa integrato sul manico superiore.
- Cremagliera a 5 posizioni.

~~€ 65,00~~ | **€ 45,50**

## 178 N

**Pinza regolabile a cerniera sovrapposta**

- Modello regolabile a 8 posizioni.
- Manici rivestiti con guaina in PVC.
- Esecuzione sabbata e verniciata.
- Corpo in acciaio.
- Dotata di arresto di sicurezza, protezione delle dita in ogni posizione di apertura.

CODICE	APERT. (mm)	L (mm)
--------	-------------	--------

U01780011	30	180	€ 18,40   <b>€ 12,90</b>
-----------	----	-----	--------------------------

U01780012	44	250	€ 23,00   <b>€ 16,10</b>
-----------	----	-----	--------------------------

## PINZE ISOLATE 1000 V

**CERNIERA APERTA CON  
ARTICOLAZIONE FORGIATA**

**EN 60900**



**TAGLIANTI TEMPRATI  
AD INDUZIONE**

per la massima efficacia  
nel taglio del filo dolce, di  
media durezza e duro.

**IMPUGNATURE ERGONOMICHE  
ISOLATE BIMATERIALE**



**2**

PEZZI



**1000 V**

**085 EX/SE2**

Cod. U00850120

Assortimento con pinza universale e  
tronchese a tagliente diagonale isolati 1000 V

- 085 EX 180.
- 087 EX 160.

~~€ 73,50~~ | **€ 51,50**



**3**

PEZZI



**1000 V**

**085 EX/SE3**

Cod. U00850121

Assortimento con pinza universale, pinza  
a becchi mezzotondi diritti e tronchese a  
tagliente diagonale isolati 1000 V

- 081 EX 160.
- 085 EX 180.
- 087 EX 160.

~~€ 112,50~~ | **€ 79,00**

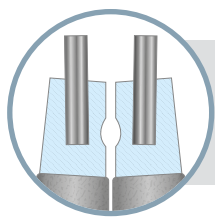

## MASSIMA RESISTENZA

Punte in acciaio armonico inserite nei becchi.

4

PEZZI



4

PEZZI



127 N/SE4S

Cod. U01270046

Serie 4 pinze per anelli elastici

- Pinze per anelli elastici interni **127 N** 12÷25-**127 PN** 12÷25.
- Pinze per anelli elastici esterni **128 N** 10÷25-**128 PN** 10÷25.

~~€ 82,50~~ | **€ 58,00**

Misure piccole

127 N/SE4

Cod. U01279000P

Serie 4 pinze per anelli elastici

- Pinze per anelli elastici interni **127 N** 19÷60-**127 PN** 19÷60.
- Pinze per anelli elastici esterni **128 N** 19÷60-**128 PN** 19÷60.

~~€ 89,50~~ | **€ 63,00**

Misure grandi

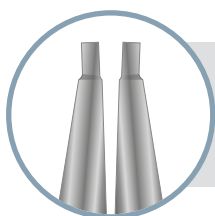

## MASSIMA ACCESSIBILITÀ

Punte e becchi in corpo unico.

4

PEZZI



4

PEZZI



127 C/SE4S

Cod. U01270045

Serie 4 pinze per anelli elastici

- Pinze per anelli elastici interni **127 C** 12÷25-**127 CP** 12÷25.
- Pinze per anelli elastici esterni **128 C** 10÷25-**128 CP** 10÷25.

~~€ 69,00~~ | **€ 48,30**

Misure piccole

127 C/SE4

Cod. U01270040

Serie 4 pinze per anelli elastici

- Pinze per anelli elastici interni **127 C** 19÷60-**127 CP** 19÷60.
- Pinze per anelli elastici esterni **128 C** 19÷60-**128 CP** 19÷60.

~~€ 75,00~~ | **€ 52,50**

Misure grandi

## SUPPORTI COMPATTI CON SISTEMA DI ESTRAZIONE RAPIDA



Estrazione della singola chiave senza muovere le altre.



I denti d'aggancio garantiscono la tenuta delle chiavi nel supporto.

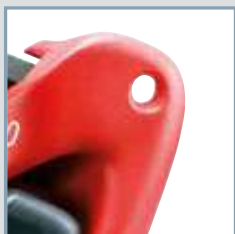

Il foro permette di appendere il supporto.



9 PEZZI



280 LTS/S9

Cod. U02800084

Serie di 9 chiavi maschio esagonale lunghe testa sferica

- 280 LTS/1,5-2-2,5-3-4-5-6-8-10 mm.

~~€ 29,30~~ | € 18,30



8 PEZZI



280 LTSTX/S8

Cod. U02800078

Serie di 8 chiavi maschio lunghe testa sferica TORX®

- 280 LTSTX/T10-T15-T20-T25-T27-T30-T40-T45.

~~€ 53,00~~ | € 37,10



9 PEZZI



280 XLTS/S9

Cod. U02800184

Serie di 9 chiavi maschio esagonale extra-lunghe a testa sferica

- 280 XLTS/1,5-2-2,5-3-4-5-6-8-10 mm.

~~€ 32,40~~ | € 23,00

**Modello Extra lungo +30% rispetto alle 280 LTS**



## NUOVE CHIAVI MASCHIO CON IMPUGNATURA



Chiavi USAG



Altre chiavi

### SIGUREZZA GARANTITA

- +30% resistenza alla torsione rispetto alla norma ISO 2936.
- Raggiunta la coppia di rottura, la chiave si deforma senza spezzarsi.



**IMPUGNATURA BIMATERIALE ERGONOMICA.**

**ACCIAIO SPECIALE AL CROMO VANADIO.**



**Stessa lama delle chiavi 280 T**

6 PEZZI



**280 HG/SE6**

Cod. U02801460

Serie di 6 chiavi maschio esagonale con impugnatura

- 280 HG/2,5-3-4-5-6-8 mm.

~~€ 67,00~~ | **€ 48,00**



6 PEZZI



**280 HGTS/SE6**

Cod. U02801463

Serie di 6 chiavi maschio esagonale a testa sferica con impugnatura

- 280 HGTS/2,5-3-4-5-6-8 mm.

~~€ 74,00~~ | **€ 53,00**



6 PEZZI



**280 HAP/SE6**

Cod. U02800462

Serie di 6 chiavi maschio esagonale in pollici con impugnatura

- 280 HAP/1/4-7/32-5/32-5/16-3/8-3/16".

~~€ 67,50~~ | **€ 49,00**

6 PEZZI



**280 HATX/SE6**

Cod. U02800464

Serie di 6 chiavi maschio con impugnatura per viti con impronta TORX®

- 280 HATX/T8-T10-T15-T20-T25-T30.

~~€ 51,50~~ | **€ 38,00**

## CHIAVE 280 T



YouTube



**ACCIAIO SPECIALE**  
al cromo vanadio.



**TRAVERSINO FISSO**  
Massima resistenza.



**CHIAVI USAG** **ALTRE CHIAVI**

### **SICUREZZA GARANTITA**

- +30% resistenza alla torsione rispetto alla norma ISO 2936.
- Raggiunta la coppia di rottura, la chiave si deforma senza spezzarsi.

**7**  
PEZZI



### **280 T/SE7**

**Cod. U02800903**

**Serie di 7 chiavi a T con maschio esagonale**

- 280 T/2-2,5-3-4-5-6-8 mm.
- Per viti con esagono incassato.
- Acciaio speciale altamente legato al cromo vanadio.
- Esecuzione cromata con estremità brunito.

~~€ 103,00~~ | **€ 72,50**

**8**  
PEZZI



### **280 TTX/SE8**

**Cod. U02800686**

**Serie di 8 chiavi a T per viti con impronta TORX®**

- 280 TTX/T6-T7-T8-T9-T10-T15-T20-T25.
- Per viti con esagono incassato.
- Acciaio speciale altamente legato al cromo vanadio.
- Esecuzione cromata con estremità brunito.

~~€ 146,00~~ | **€ 102,00**



6  
PEZZI



Testa  
sferica

## 280 TTS/SE6

Cod. U02800760

**Serie di 6 chiavi a T maschio esagonali con testa sferica**

- 280 TTS/2,5-3-4-5-6-8 mm.
- Per viti con esagono incassato.
- Acciaio speciale altamente legato al cromo vanadio.
- Esecuzione cromata con estremità brunate.
- Modello che permette di operare con inclinazioni fino a 30° rispetto all'asse della vite.
- Massima accessibilità con la testa sferica.

~~€ 90,50~~ | € 63,50



4  
PEZZI



Testa  
sferica

## 280 TSTX/SE4

Cod. U02800790

**Serie di 4 chiavi a T con impronta TORX® a testa sferica**

- 280 TSTX/T15-T20-T25-T30.
- Acciaio speciale altamente legato al cromo vanadio.
- Esecuzione cromata con estremità brunate.
- Modello che permette di operare con inclinazioni fino a 30° rispetto all'asse della vite.
- Massima accessibilità con la testa sferica.

~~€ 75,50~~ | € 53,00



6  
PEZZI



Traversino  
scorrevole

## 280 TK/SE6

Cod. U02800020

**Serie di 6 chiavi a T maschio esagonale con traversino scorrevole**

- 280 TK/2,5-3-4-5-6-8 mm.
- Per viti con esagono incassato.
- Traversino scorrevole che permette di avere maggiore accessibilità rispetto alla chiave standard.
- Fermo di sicurezza che impedisce l'estrazione del traversino.
- Acciaio speciale altamente legato al cromo vanadio.
- Esecuzione cromata con estremità brunate per il gambo.
- Esecuzione interamente brunita per il traversino.
- Estremità dimensionate per il perfetto accoppiamento con la vite.

~~€ 93,50~~ | € 65,00



**32**  
PEZZI

1/4



280 g | 138 mm  
30 mm  
98

## 692 J32

Cod. U06920042

Assortimento di inserti con cricchetto

DESCRIZIONE	MISURA	PZ.
Inserti ad intaglio	4-5,5-6,5-8	4
Inserti a croce PHILLIPS®	PH 1-2-3	3
Inserti a croce POZIDRIV®	PZ 1-2-3	3
Inserti esagono maschio	3-4-5-6	4
Inserti TORX®	T8-10-15-20-25-30-40	9
Inserti TORX® Tamper Resistant	STX 10-15-20-25-27-30-40	7
Portainseri magnetico		1
Cricchetto		1

~~€ 47,10~~ | **€ 32,50**



**49**  
PEZZI

1/4



280 g | 138 mm  
30 mm  
98

## 692 J49

Cod. U06920041

Assortimento di inserti

DESCRIZIONE	MISURA	PZ.
Inserti ad intaglio	4-4,5-5,5-6,5-6,5-8	6
Inserti a croce PHILLIPS®	PH 1-1-2-2-2-3	6
Inserti a croce POZIDRIV®	PZ 1-1-2-2-2-3-3	7
Inserti esagono maschio	2-3-3-4-4-5-5-6-6	9
Inserti TORX®	TX 10-10-15-15-20-20-25-25-30-30	10
Inserti TORX® Tamper Resistant	STX 10-15-15-20-20-25-25-30-40	10
Portainseri magnetico		1

~~€ 36,40~~ | **€ 27,00**



**100**  
PEZZI

1/4



900 g | 215 mm  
45 mm  
150

## 692 J100

Cod. U06920043

Assortimento di inserti con impronte speciali

DESCRIZIONE	MISURA	PZ.
Inserti a intaglio	3-4-4,5-5-5,5-6-6,5-7-8	9
Inserti a croce	PH 00-0-1-1-2-2-3-4 - PZ 1-2-2-3-4	13
Inserti esagono maschio	1,5-2-2,5-3-4-5-5,5-6-7-8 mm 1/16-5/64-3/32-7/64-1/8-9/64-5/32-3/16-7/32-1/4"	20
Inserti TORX®	T 8-9-10-15-20-25-27-30-40-45	10
Inserti TORX® Tamper Resistant	STX 8-10-15-20-25-27-30-35-40	9
Inserti Tri-Wing	1-2-3-4	4
Inserti Spanner	4-6-8-10-12	5
Inserti Torq-set	6-8-10	3
Inserti quadrati	0-1-2-2-3	5
Inserti Clutch	1/8-5/32-3/16-1/4-5/16	5
Inserti XZN	M5-M6-M8	3
Inserti esagono maschio con foro	2-2,5-3-4-5-6 mm - 5/64-3/32-7/64-1/8-9/64-5/32"	12
Portainseri magnetici	1/4x60mm	2

~~€ 56,00~~ | **€ 41,50**



Cricchetto



Giravite a T



Giravite corto



8

PEZZI



1/4



## 333 K/S8

Cod. U03330042

Assortimento COMBIDRIVE con inserti

DESCRIZIONE	MISURA	PZ.
Impugnatura Combidrive	333 K	1
Lama portainseri magnetica	333 1/4 MG	1
Inserti ad intaglio	660/0,6x4,5-1x5,5	2
Inserti a croce PH	660 PH 1-2	2
Inserti esagonali	660 E 3-4	2

~~€ 55,00~~ | **€ 38,50**



5,5-6-7-8  
10-12-13 mm



7

PEZZI



1/4

## 664 B/S7

Cod. U06640015

Assortimento di inserti a bussola

- Fornito in cassetta di plastica

~~€ 31,40~~ | **€ 22,00**



25

PEZZI



1/4

## 664 S25

Cod. U06640111

Assortimento di inserti per avvitatura

- Fornito in cassetta di plastica

DESCRIZIONE	MISURA	PZ.
Inserti lunghi ad intaglio	3-4-5-6	4
Inserti lunghi a croce PH	1-2(x2)-3(x2)	5
Inserti lunghi a croce PZ	1-2(x2)-3(x2)	5
Inserti lunghi TORX®	T15-T20-T25-T30-T40	5
Inserti lunghi esagonali	2-3-4-5-5,5	5
Portainseri magnetico		1

Riconoscimento dell'inserto con codice colore per una scelta rapida

~~€ 58,50~~ | **€ 39,00**

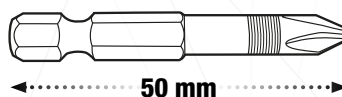

## ESTRATTORI 458 E PER VITI ESAGONALI DANNEGGIATE



9  
PEZZI



2-2,5-3-4-5-  
6-7-8 mm



 Bussola  
1/4 portainseri

458 E/B9

Cod. U04580313



### Set di estrattori per viti esagonali danneggiate

- Profilo speciale esclusivo.
- Permettono di svitare viti esagonali anche molto danneggiate.
- In acciaio speciale con finitura fosfatata.
- Attacco esagonale da 1/4".
- Inclusa bussola portainseri 1/4-1/4".
- Fornito in astuccio di tessuto compatto.

DESCRIZIONE	ART./MISURA	PZ.
Estrattori per viti esagonali danneggiate 458 E 2-2,5-3-4-5-6-7-8		8
Bussola portainseri	684 1/4	1

~~€ 43,10~~ | **€ 29,90**

## EFFICACE ANCHE SU VITI MOLTO DANNEGGIATE

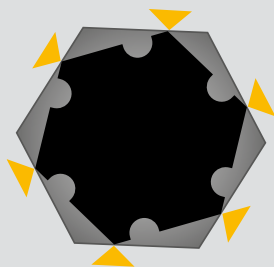

### PROFILO ESCLUSIVO

Lo speciale design con cui sono realizzati gli inserti, permette di fare presa sugli esagoni incassati in qualunque condizione: intatti o completamente danneggiati.

### VITI DANNEGGIATE

Quando una vite con esagono incassato si danneggia, non è più possibile svitarla con normali chiavi maschio esagonali. I nuovi estrattori 458 E permettono di svitare anche viti danneggiate fino al 98% del profilo esagonale.



  
1/4



 YouTube



**20**  
PEZZI

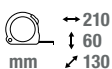

## 458 S20

Cod. U04580312

### Assortimento di estrattori per viti e dadi esagonali danneggiati

- Composto da estrattori per profili esagonali esterni o incassati.
- Permettono di svitare viti e dadi esagonali anche molto danneggiati.
- In acciaio speciale con finitura fosfatata.
- 458 B: bussole con attacco 3/8" o 1/2" e profilo elicoidale conico.
- 458 E: inserti con attacco 1/4" e profilo speciale esclusivo.
- Inclusa bussola portainseri 1/4-1/4".
- Cassetta in ABS ad alta resistenza.
- Modulo interno in spugna bicolore.

DESCRIZIONE	ART./MISURA	PZ.
Estrattori per viti e dadi esagonali danneggiate	458 B 8-10-11-12-13-14-15-16-17-18-19	11
Estrattori per viti esagonali danneggiate	458 E 2-2,5-3-4-5-6-7-8	8
Bussola portainseri	684 1/4	1

~~€ 179,00~~ | **€ 120,00**

## KIT COMPLETO PER VITI E DADI DANNEGGIATI



### PROFILO ESCLUSIVO PER ESAGONI INCASSATI

Lo speciale design degli inserti permette di fare presa su esagoni incassati intatti o completamente danneggiati.

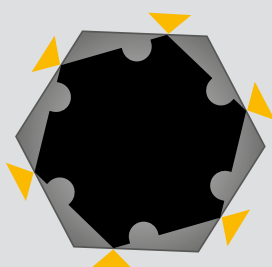

**2-2,5-3-4-5-  
6-7-8 mm**



### PROFILO ELICOIDALE PER DADI E VITI ESAGONALI

Le bussole elicoidali coniche garantiscono una presa esterna efficace su esagoni danneggiati.

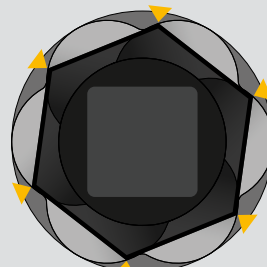

**8-10-11-12-13-  
14-15-16-17-  
18-19 mm**

## 454

### Estrattori a due bracci per esterni

- Modello a bracci scorrevoli.
- Trave con esagono di supporto al serraggio.
- Bracci con unghiate ridotte.
- Vite in acciaio al carbonio.
- Corpo in acciaio al cromo vanadio.
- Esecuzione cromata e brunita.

CODICE	A	B	POTENZA	ESAGONO	PREZZO	PREZZO
U04540000	65 mm	70 mm	1,5 t	13 mm	€ 71,00	€ 49,70
U04540010	90 mm	110 mm	3 t	17 mm	€ 80,00	€ 56,00
U04540020	130 mm	110 mm	3 t	17 mm	€ 86,00	€ 60,50
U04540030	175 mm	165 mm	4 t	17 mm	€ 139,00	€ 97,50
U04540040	220 mm	165 mm	4 t	17 mm	€ 154,00	€ 108,00
U04540050	270 mm	220 mm	5 t	21 mm	€ 215,00	€ 151,00
U04540060	340 mm	220 mm	5 t	21 mm	€ 241,00	€ 169,00



4  
PEZZI

COMPRESSE  
NEL PREZZO

## 451 N/S4

Cod. U04510100

### Estrattore a tre bracci per esterni

- Modello a bracci autoserranti.
- Capacità: 7÷140 mm.
- Potenza: 3 ton.
- Spina di sicurezza.
- Vite di manovra con esagono da 18 mm.
- Possibilità di utilizzo a due bracci.
- Viti di manovra M16x2.

€ 295,00 | € 149,00

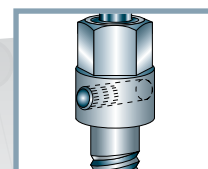

Spina di sicurezza:  
utilizzo sicuro e qualità  
dell'attrezzo preservata

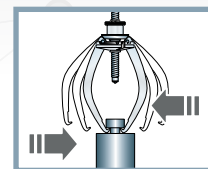

Autoserrante  
Autocentrante

## ESTRATTORI PER PRIGIONIERI E VITI SPEZZATE

Ø 6÷14  
mm

25  
PEZZI



460 A

Cod. U04600080

### Serie di estrattori per prigionieri

- Fornita in cassetta in materiale plastico.

€ 142,00 | € 99,00



Ø 1÷6  
mm

6  
PEZZI



458 S6

Cod. U04580012

### Serie di 6 estrattori conici

- Per la rimozione di viti o prigionieri spezzati che non offrono possibilità di presa.

€ 23,80 | € 16,70



**APERTURA  
MAGGIORATA +20%**



YouTube

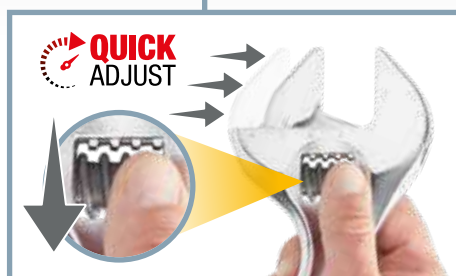

**ARRETRI IL RULLINO,  
REGOLI RAPIDAMENTE.**

**RUOTI IL RULLINO,  
REGOLI CON PRECISIONE.**

## 294 AD

### Chiavi a rullino con regolazione rapida

- Si regola rapidamente arretrando il rullino.
- Grande capacità: apertura +20% rispetto allo standard.
- Doppia scala graduata: millimetri e pollici.
- Testa inclinata di 22°.
- Rullino in acciaio.
- Asola di aggancio.
- Finitura cromata.

CODICE	L	APERTURA	
U02940011	110 mm - 4"	17 mm	€ 16,70   <b>€ 11,70</b>
U02940012	150 mm - 6"	23 mm	€ 17,50   <b>€ 12,30</b>
U02940013	200 mm - 8"	33 mm	€ 20,90   <b>€ 14,70</b>
U02940014	250 mm - 10"	38 mm	€ 26,60   <b>€ 18,70</b>
U02940015	300 mm - 12"	41 mm	€ 34,90   <b>€ 24,50</b>
U02940016	380 mm - 15"	50 mm	€ 64,00   <b>€ 44,80</b>
U02940017	460 mm - 18"	63 mm	€ 105,00   <b>€ 73,50</b>

**APERTURA  
MAGGIORATA +20%**



YouTube

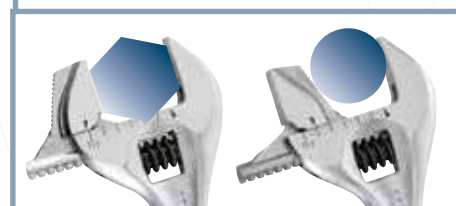

### INVERTI

**LA GANASCIA MOBILE**  
per passare dalla presa su  
esagono a quella su tondo.

**POSIZIONE  
STANDARD**

**GANASCIA  
INVERTITA**

## 294 AG

### Chiavi a rullino reversibili con impugnatura

- Nella posizione standard può manovrare un profilo esagonale.
- Invertendo il dente mobile, può manovrare un profilo tondo.
- Grande capacità: apertura +20% rispetto allo standard.
- Doppia scala graduata: millimetri e pollici.
- Impugnatura ergonomica bimateriale.
- Testa inclinata di 22°.
- Rullino in acciaio.
- Asola di aggancio.
- Finitura cromata.

CODICE	L	APERTURA	
U02940023	200 mm - 8"	33 mm	€ 22,90   <b>€ 16,10</b>
U02940024	250 mm - 10"	38 mm	€ 29,20   <b>€ 20,50</b>
U02940025	300 mm - 12"	41 mm	€ 38,40   <b>€ 26,90</b>

**APERTURA  
MAX 34 mm**



**Solo 150 mm**

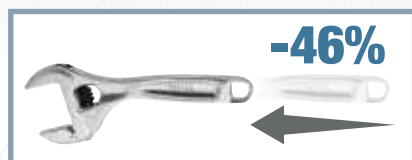

**LUNGHEZZA RIDOTTA  
DEL 46% RISPETTO AD  
UNA CHIAVE STANDARD**

## 294 AC

**Cod. U02940010**

### Chiave regolabile a rullino corta

- Lunghezza ridotta del 46% rispetto ad una chiave standard.
- Apertura ganasce pari ad una chiave a rullino da 12".
- Leggera e compatta per un'ottima accessibilità.
- Regolazione tramite rullino in acciaio.
- Scala millimetrata sulla testa della chiave.
- Finitura cromata.

~~€ 20,80~~ | **€ 14,60**

## 285 CHIAVE COMBINATA



YouTube

### FORCHETTA INCLINATA

Angolo di 15° rispetto all'asse della chiave.



### SEZIONE A DOPPIA T

Massima resistenza alla flessione.

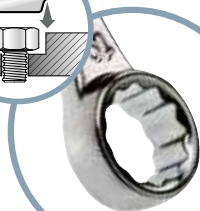
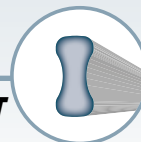

### OCCHIO DISASSATO

Per dadi e bulloni incassati in posizioni di difficile accesso.

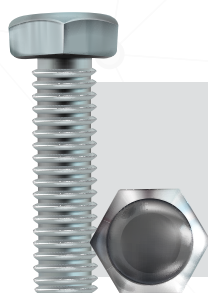

### TOP PERFORMANCE

Resistenza alla torsione statica di anello e forchetta: +50% rispetto alla norma ISO 1711-1.

ISO 1711-1  
SAE AS 954E



8  
PEZZI

8÷19 mm

285 DS8

Cod. U02850863

Serie di 8 chiavi combinate

- 285/8-10-11-12-13-14-17-19 mm.
- Fornita con supporto in plastica.

~~€ 69,50~~ | € 45,00



26  
PEZZI

6÷32 mm

285 SE26

Cod. U02850861

Serie di 26 chiavi combinate

- 285/6-7-8-9-10-11-12-13-14-15-16-17-18-19-20-21-22-23-24-25-26-27-28-29-30-32 mm.

~~€ 309,00~~ | € 211,00

## 285 KA

### CHIAVE COMBINATA A CRICCHETTO CON ANELLO DI TENUTA

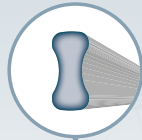

#### SEZIONE A DOPPIA T

Massima resistenza  
alla flessione.

#### POSIZIONE OTTIMALE



#### ANELLO IN ACCIAIO ARMONICO INTEGRATO NELL'OCCHIO POLIGONALE

Mantiene la posizione sul dado  
durante la manovra.



#### FORCHETTA CON SISTEMA ANTISLITTAMENTO DEL DADO

Maggiore tenuta durante la manovra.

#### CRICCHETTO RESISTENTE

Resistenza alla torsione statica del cricchetto:  
+50% rispetto alla norma ISO 1711-1.



YouTube

8

PEZZI



8÷19 mm



12

PEZZI



7÷19 mm



#### 285 KA/DS8

Cod. U02856058

Serie di 8 chiavi combinate a cricchetto  
con anello di tenuta

- 285 KA/8-10-11-12-13-14-17-19 mm.

~~€ 139,50~~ | **€ 93,00**

#### 285 KA/DS12

Cod. U02856062

Serie di 12 chiavi combinate a cricchetto  
con anello di tenuta

- 285 KA/7-8-10-11-12-13-14-15-16-17-18-19 mm.

~~€ 211,00~~ | **€ 149,00**

8 PEZZI

6÷22 mm

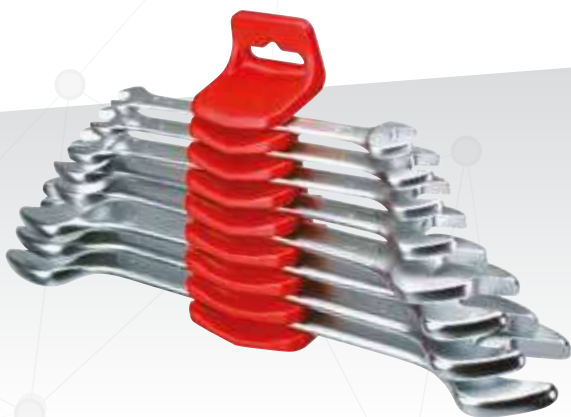

9 PEZZI

6÷23 mm



8 PEZZI

8÷19 mm



TESTA SNODATA

8 PEZZI

8÷19 mm



CAMBIO DEL SENSO DI ROTAZIONE



252 N/SR8

Cod. U02520862

Serie di 8 chiavi a forchetta doppie

- 252 N/6x7-8x9-10x11-12x13-14x15-16x17-18x19-20x22 mm.

~~€ 52,00~~ | € 36,40



283 SE9

Cod. U02831405

Serie di 9 chiavi poligonali doppie curvate

- 283/6x7-8x9-10x11-12x13-14x15-16x17-18x19-20x22-21x23 mm.

~~€ 100,50~~ | € 59,00



285 KF/DS8

Cod. U02856158

Serie di 8 chiavi combinate a cricchetto snodate

- 285 KF/8-10-11-12-13-14-17-19 mm.

~~€ 163,50~~ | € 115,00



285 KB/SR8

Cod. U02856339

Serie di 8 chiavi combinate a cricchetto piatte

- 285 KB/8-10-12-13-14-15-17-19 mm.

~~€ 108,00~~ | € 76,00

4

PEZZI



7÷13 mm



Torsione massima  
10 Nm



## 298 SN/SE4

Cod. U02980288

Serie di 4 chiavi flessibili a bussola esagonale con impugnatura

- 298 SN/7-8-10-13 mm.

~~€ 100,00~~ | € 70,00

4

PEZZI



7÷13 mm



## 299 SE4

Cod. U02990200

Serie di 4 chiavi a bussola esagonale con impugnatura

- 299/7-8-10-13 mm.

~~€ 61,00~~ | € 42,70

8

PEZZI



7÷19 mm



## 276 CE/SE8

Cod. U02760484

Serie di 8 chiavi a T snodate

- 276 CE/7-8-10-12-13-14-17-19 mm.

~~€ 240,50~~ | € 168,00

## LO SNODO CARDANICO USAG

- Molla di frizione interna per il perfetto preposizionamento della bussola.
- Bussola e cardano fissati con un perno in acciaio ribadito per la massima affidabilità.
- Chiavi progettate e prodotte rispettando la normativa UNI 6743.



## 237 A

### CRICCHETTO REVERSIBILE CON MECCANISMO SIGILLATO IP51



Sistema di inversione integrato nel coperchio



Spessore della testa ridotto rispetto ai modelli standard



**IMPUGNATURA CONICA**  
in bimateriale e antiscivolo.

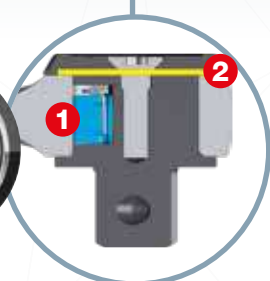

1. Nottolino brevettato.
2. Diaframma protettivo.

### TOP PERFORMANCE

1. Resistenza alla torsione statica:  
+30% di coppia rispetto alla norma ISO 3315 grazie al nottolino brevettato.
2. Resistenza a fatica:  
dura il doppio dei normali cricchetti del mercato grazie alla protezione IP51.



23  
PEZZI

1 1/2"



606 1/2" EA

Cod. U06060302



**Assortimento in cassetta di ABS con bussole esagonali**

- Cassetta in ABS ad alta resistenza con sistema di chiusura rapida.

DESCRIZIONE	ART./MISURA	PZ.
Chiavi a bussola con bocca esagonale	235 1/2 EN 8-9-10-11-12-13-14-15-16-17-18-19-21-22-23-24-27-30-32	19
Prolunghe	236 1/2 125-250	2
Snodo cardanico	241 1/2	1
Cricchetto reversibile certificato IP51	237 A 1/2	1



19  
PEZZI

1 1/4"



606 1/4" EA

Cod. U06060101



**Assortimento in cassetta di ABS con bussole esagonali**

- Cassetta in ABS ad alta resistenza con sistema di chiusura rapida.

DESCRIZIONE	ART./MISURA	PZ.
Chiavi a bussola con bocca esagonale	235 1/4 EN 4-4.5-5-5.5-6-7-8-9-10-11-12-13-14	13
Prolunghe	236 1/4 50-100	2
Snodo cardanico	241 1/4	1
Leva a T con attacco quadro scorrevole	240 1/4	1
Portabussole con impugnatura	243 1/4	1
Cricchetto reversibile certificato IP51	237 A 1/4	1

~~€ 114,00~~ | **€ 70,00**

~~€ 216,00~~ | **€ 130,00**

## BUSSOLE IN MILLIMETRI E POLLICI



35  
PEZZI

1 1/2"



### 612 1/2" MPA

Cod. U06122014



#### Assortimento in cassetta di lamiera con bussole poligonali

DESCRIZIONE	ART./MISURA	PZ.
Chiavi a bussola con bocca poligonale	235 1/2 N 10-11-12-13-14-15-16-17-18-19-22-24-27-30-32	15
Chiavi a bussola in pollici con bocca poligonale	235 1/2 PN 3/8-7/16-1/2-9/16-5/8-11/16-3/4-13/16-7/8-15/16-1-1 1/16-1 1/8-1 3/16-1 1/4	15
Prolunghe	236 1/2 125-250	2
Snodo cardanico	241 1/2	1
Leva a T scorrevole	240 1/2 N	1
Cricchetto reversibile certificato IP51	237 A 1/2	1

~~€ 375,00~~ | **€ 263,00**



17  
PEZZI

3 4"



### 612 3/4" EB

Cod. U06120017



#### Assortimento in cassetta di lamiera con bussole esagonali

DESCRIZIONE	ART./MISURA	PZ.
Chiavi a bussola con bocca esagonale	235 3/4 N 22-23-24-26-27-28-30-32-36-38-41-46-50	13
Prolunghe	236 3/4 200-400	2
Leva a T scorrevole	240 3/4 N	1
Cricchetto reversibile con meccanismo sigillato 120 denti	237 B 3/4	1

~~€ 502,50~~ | **€ 352,00**

### 612 3/4" B

Cod. U06120016



**BUSSOLE POLIGONALI**

#### Assortimento in cassetta di lamiera con bussole poligonali

~~€ 502,50~~ | **€ 352,00**



12  
PEZZI

1"

### 612 1" ESI

Cod. U06120019

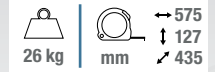

#### Assortimento in cassetta di lamiera con bussole esagonali

DESCRIZIONE	ART./MISURA	PZ.
Chiavi a bussola con bocca esagonale	235 1 EN 46-50-55-60-65-70-75-80	8
Prolunghe	236 1 200-415	2
Leva a T scorrevole	240 1 N	1
Cricchetto reversibile	237 1 SI	1

~~€ 873,50~~ | **€ 611,00**

# IL TOP PER GLI SPAZI RISTRETTI



**50  
PEZZI**

**1  
4"**



**608 1/4" EAK**

**Cod. U06080305**



**Assortimento in cassetta di ABS con prolunghe, cricchetto e bussole esagonali**

- Cassetta in ABS ad alta resistenza con sistema di chiusura rapida.

DESCRIZIONE	ART./MISURA	PZ.
Chiavi a bussola con bocca esagonale	235 1/4 EN 4-4,5-5-5,5-6-7-8-9-10-11-12-13-14	13
Cricchetto con impugnatura rotante	237 1/4 AK	1
Portabussole con impugnatura	243 1/4	1
Portabussole flessibile con impugnatura	243 1/4 SN	1
Chiave a T con attacco quadro snodato	273 1/4 Q	1
Assortimento inserti con cricchetto reversibile - mini kit	606 1/4 SK	31
Raccordo aumentatore	247 1/4	1
Bussole portainseri	684/1	1

~~€ 230,35~~ | **€ 159,00**

**NEW**



**CHIAVE A T  
SNODATA**



**IMPUGNATURA CON  
LAMA FLESSIBILE**



**CRICCHETTO CON  
IMPUGNATURA ROTANTE**



**CRICCHETTO PORTA  
INSERTI SNODATO**

## CRICCHETTI CON IMPUGNATURA ROTANTE

**1  
4"**



**237 1/4" AK**

**Cod. U02370003**

**Cricchetto reversibile 1/4" con impugnatura rotante**

~~€ 45,60~~ | **€ 32,00**

**1  
2"**



**237 1/2" AK**

**Cod. U02370009**

**Cricchetto reversibile 1/2" con impugnatura rotante**

~~€ 74,50~~ | **€ 52,50**





38  
PEZZI

1/4"



900 g | 155 mm  
50 mm  
95

## 609 1/4" EB

Cod. U06090002



### Assortimento con bussole esagonali ed inserti per avvitatura

- Cassetta compatta in bimatereale con rivestimento soft-touch.

DESCRIZIONE	ART./MISURA	PZ.
Bussole esagonali	235 1/4" EN 5,5-6-7-8-9-10-11-12-13-14 mm	10
Prolunghe	236 1/4" 50-100	2
Cricchetto reversibile	237 B 1/4"	1
Snodo cardanico	241 1/4"	1
Impugnatura porta-bussole	243 1/4"	1
Inserti ad intaglio	660 0,6x4,5-1x5,5-1,2x6,5	3
Inserti PH	660 PH 1-2-3	3
Inserti PZ	660 PZ 1-2-3	3
Inserti esagonali	660 E 2-3-4-5-6	5
Inserti TORX® Tamper Resistant	660 STX T10-T15-T20-T25-T27-T30-T40	7
Inserto porta-bussole	660 Q 1/4"	1
Bussole porta-inserti	684 1/4"-1/4"	1



YouTube

€ 181,00 | € 127,00

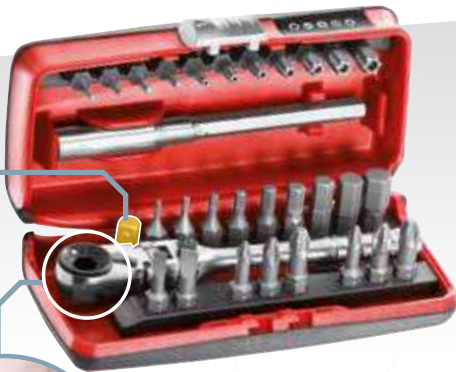

Inserto portabussole

31  
PEZZI

1/4"



350 g | 120 mm  
35 mm  
65



## 606 1/4" SK

Cod. U06060012

YouTube



### Assortimento inserti con cricchetto reversibile

DESCRIZIONE	ART./MISURA	PZ.
Cricchetto reversibile	237 1/4" SFK	1
Inserti ad intaglio	660 0,5x4-1x5,5	2
Inserti esagonali	660 E 1,5-2-2,5-3-4-5-6-7-8	9
Inserti a croce PHILLIPS®	660 PH 1-2-3	3
Inserti a croce POZIDRIV®- SUPADRIV®	660 PZ 1-2-3	3
Raccordo portainseriti	660 Q 1/4"	1
Inserti TORX® Tamper Resistant	660 STX T10-T15-T20-T25-T27-T30-T40	7
Inserti TORX®	660 TX T6-T7-T8-T9	4
Prolunga magnetica	672 1/4" MG 100	1

€ 62,50 | € 45,00



11  
PEZZI

1/4"

11 mm



265 g | 120 mm  
35 mm  
65

5,5-6-7-8-9-10-11-12-13-14 mm

## 610 1/4" EFK

Cod. U06100001

YouTube



### Assortimento bussole ribassate con cricchetto reversibile

€ 82,50 | € 55,00

#### BUSSOLE ESAGONALI RIBASSATE

Garantiscono il doppio dell'accessibilità rispetto all'utilizzo di un cricchetto standard.

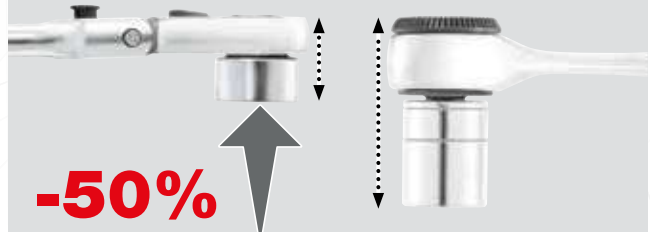

-50%



**16**  
PEZZI

1 2"

1 4"



1 kg | mm | 190  
58  
144

## 601 1/4-1/2 JTX16

Cod. U06010009

**Assortimento in cassetta modulare con bussole TORX®**

DESCRIZIONE	MISURA	PZ.
Chiavi a bussola 1/4 TORX®	E6-E7-E8-E10	4
Chiavi a bussola 1/2 TORX®	E12-E14-E16-E18	4
Chiavi a bussola 1/4 con inserto TORX®	T10-T15-T20-T25	4
Chiavi a bussola 1/2 con inserto TORX®	T30-T40-T45-T50	4

~~€ 37,70~~ | **€ 26,50**



**34**  
PEZZI

1 4"



1 kg | mm | 190  
58  
144

## 601 1/4 J34

Cod. U06010001

**Assortimento in cassetta modulare con bussole esagonali ed inserti per avvitatura**

DESCRIZIONE	MISURA	PZ.
Chiavi a bussola 1/4"	4-4,5-5-5,5-6-7-8-9-10-11-12-13-14	13
Cricchetto reversibile 1/4"		1
Snodo cardanico 1/4"		1
Prolunghe 1/4"	55-100	2
Inserti a intaglio	4-5,5-6	3
Inserti a croce POZIDRIV®	1-2-3	3
Inserti esagono maschio	4-5-6	3
Inserti TORX®	T10-T15-T20-T25-T30-T40	6
Impugnatura maschio/femmina		1
Raccordo portainseriti 1/4"		1

~~€ 61,00~~ | **€ 42,00**



**22**  
PEZZI

1 2"



4 kg | mm | 375  
80  
186

## 601 1/2 J22

Cod. U06010003

**Assortimento in cassetta modulare con bussole esagonali**

DESCRIZIONE	MISURA	PZ.
Bussole esagonali 1/2"	8-10-11-12-13-14-15-16-17-18-19-21-22-24-27-30-32	17
Cricchetto 1/2"		1
Prolunghe 1/2"	130-250	2
Snodo cardanico 1/2"		1
Leva a T 1/2"		1

~~€ 106,00~~ | **€ 69,00**

LA QUALITÀ **USAG** A UN PREZZO *Just*

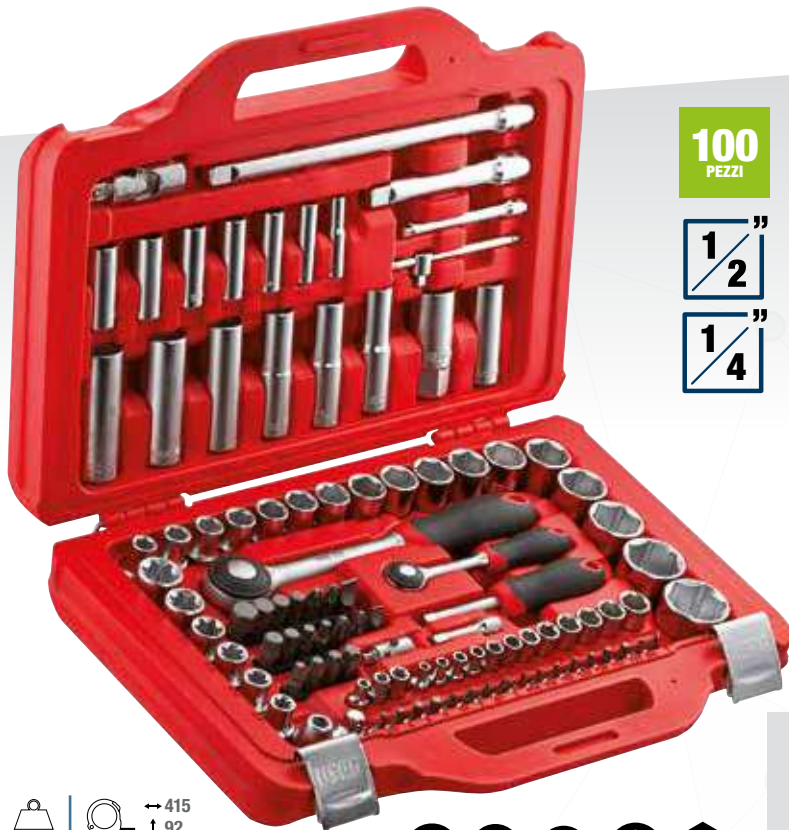

**100**  
PEZZI

1/2"

1/4"

**601 1/4-1/2 J100**

Cod. U06010011



Assortimento in cassetta modulare con bussole esagonali ed inserti per avvitatura

~~€ 177,00~~ | **€ 116,00**



Modulare con i cassettei dei carrelli USAG!

8 kg | 415 mm | 92 | 283



**82**  
PEZZI

1/2"

1/4"

**601 1/4-1/2 J82**

Cod. U06010010



Assortimento in cassetta modulare con bussole esagonali e chiavi combinate

~~€ 267,00~~ | **€ 170,00**



Modulare con i cassettei dei carrelli USAG!

7 kg | 415 mm | 92 | 283





YouTube



PRECISIONE  
±4%

1/2"



±20°

## 810 F

ISO 6789

### Chiave dinamometrica con cricchetto reversibile a testa snodata

- Testa snodata per agevolare l'utilizzo in spazi ridotti o profondi.
- Angolo di inclinazione fino a 20°.
- Scala di lettura in Nm.
- Modello a coppia regolabile per serraggi destrorsi.
- Riarmo automatico al rilascio dopo il disinnesto.
- Fornita con certificato di collaudo.

ARTICOLO	CODICE	CAPACITÀ	☑	L (mm)	RISOL.	
810 F 100	U08104013	20 ÷ 100	1/2"	447	0,25	€ 209,00   € 136,00
810 F 200	U08104015	40 ÷ 200	1/2"	500	0,5	€ 209,00   € 136,00

### ⚠ IMPORTANTE ⚠

Quando la chiave è utilizzata inclinata a +/- 20° la coppia di serraggio deve essere impostata con un incremento del +5%.  
Esempio: Coppia necessaria 90 Nm = Coppia per uso inclinato 94,5 Nm.



PRECISIONE  
±4%

1/4"

3/8"

1/2"

## 810 N

ISO 6789

### Chiave dinamometrica con cricchetto reversibile

- Modello a coppia regolabile per serraggi destrorsi.
- Riarmo automatico al rilascio dopo il disinnesto.
- Fornita con certificato di collaudo.

ARTICOLO	CODICE	CAPACITÀ	☑	L (mm)	RISOL.	
810 N 5	U08104000	1÷5	1/4"	197	0,05	€ 200,00   € 126,00
810 N 25	U08104001	5 ÷ 25	1/4"	290	0,05	€ 200,00   € 126,00
810 N 50	U08104002	10 ÷ 50	3/8"	350	0,25	€ 200,00   € 126,00
810 N 100	U08104003	20 ÷ 100	1/2"	410	0,25	€ 200,00   € 126,00
810 N 200	U08104005	40 ÷ 200	1/2"	475	0,5	€ 200,00   € 126,00
810 N 340	U08104006	68 ÷ 340	1/2"	630	1	€ 231,00   € 150,00

## 812 N

ISO 6789

### Chiavi dinamometriche con cricchetto reversibile

- **812 N 600:** Modello a coppia regolabile per serraggi destrorsi e sinistrorsi con rotazione del cricchetto di 180°.
- **812 N 1000:** Modello a coppia regolabile per serraggi destrorsi e sinistrorsi.
- Precisione ±4% del valore di coppia impostato.
- Scala di lettura in Nm.
- Segnale sensitivo e sonoro al raggiungimento della coppia impostata.
- Riarmo automatico al rilascio dopo il disinnesto.
- Blocco di sicurezza dopo la regolazione della coppia.
- Fornita in cassetta di lamiera completa di certificato di collaudo.
- Cricchetto con attacco quadro 3/4".

ARTICOLO	CODICE	CAPACITÀ	☑	
812 N 600	U08120006	120 ÷ 600	3/4"	€ 920,00   € 644,00
812 N 1000	U08120010	200 ÷ 1000	3/4"	€ 1.151,00   € 806,00

3/4"

PRECISIONE  
±4%

Serraggi controllati utilizzando cricchetti o chiavi a T

1/2"



YouTube

## 814 A

### Dispositivo digitale coppia-angolo

- Permette serraggi coppia ed angolo di precisione digitale anche con utensili tradizionali.
- Per serraggi destrorsi e sinistrorsi.
- Scala di lettura in Nm/ft.lb/in-lb/kg.cm/gradi.
- Doppia indicazione: luminosa (LED) e sonora (buzzer) al raggiungimento del valore impostato.
- 9 valori di coppia o angolo preimpostabili.
- 50 misurazioni memorizzabili.
- In custodia di ABS con certificato di taratura.
- Alimentazione: 2 batterie AAA (incluse).

CODICE	CAPACITÀ	█	RISOL.	
U08140003	6,8 - 135	1/2"	0,1	€ 230,00   <b>€ 161,00</b>
U08140004	10 - 200	1/2"	0,1	€ 256,00   <b>€ 186,00</b>
U08140005	17 - 340	1/2"	0,1	€ 321,00   <b>€ 225,00</b>

Misurazione corretta dell'angolo in qualsiasi posizione

PRECISIONE  
±2%



YouTube

## 831 A

Cod. U08310001

### Goniometro digitale

- Permette serraggi angolari di precisione digitale in totale semplicità.
- Per serraggi destrorsi e sinistrorsi.
- Precisione angolo: +/- 2%.
- Scala: 0÷360°.
- Risoluzione: 0,1°.
- Doppia indicazione : luminosa (LED) e sonora (buzzer) al raggiungimento del valore impostato.
- 9 valori di angolo preimpostabili.
- 50 misurazioni memorizzabili.
- Fornito in custodia di ABS con certificato di taratura.
- Alimentazione: 2 batterie AAA (incluse nella confezione).

~~€ 167,00~~ | **€ 109,00**

## Rapporto di moltiplicazione

1:3,4



Ingresso

Uscita

CAPACITÀ  
1400  
Nm

1/2"

3/4"

## 828 X4

Cod. U08280401

### Moltiplicatore di coppia

- Modello compatto e leggero per interventi di manutenzione su veicoli industriali e macchine agricole.
- Fornito con leva di contrasto in custodia di nylon..
- Rapporto di trasmissione 4:1.
- Coppia max in ingresso: 400 Nm.

~~€ 759,00~~ | **€ 530,00**

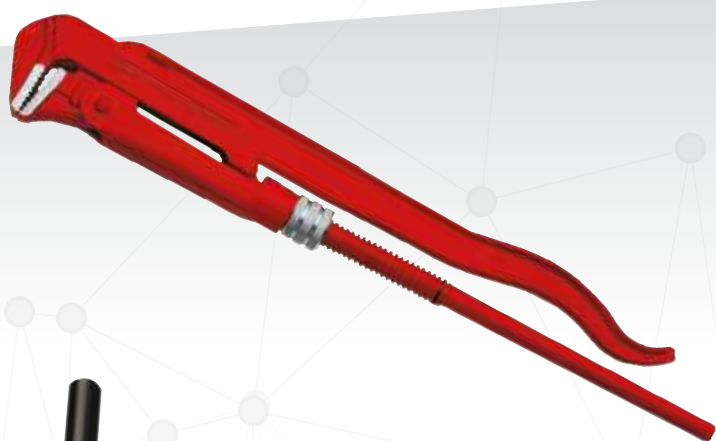

## 305 N

**Giratubi modello svedese con ganasce a 90° diritte**

- Acciaio al cromo vanadio.

CODICE	CAPACITÀ	LUNGHEZZA	
U03050002	1"	40 mm	330 mm € 34,50   <b>€ 24,30</b>
U03050003	1 1/2"	55 mm	420 mm € 46,10   <b>€ 32,30</b>
U03050004	2"	67 mm	540 mm € 71,00   <b>€ 49,70</b>
U03050005	3"	103 mm	690 mm € 106,00   <b>€ 74,50</b>



7  
PEZZI



9÷17 mm

## 307 A/S7

**Cod. U03070001**

**Chiave per sottolavelli**

- Per il montaggio di rubinetti e miscelatori con fissaggio a dado.
- Braccio cavo di 25 cm di lunghezza.
- Estremità cava per dadi esagonali di 13 mm.
- Adattatori forniti: 9,10,11,12,14,17 mm.

~~€ 38,00~~ | **€ 26,60**



**PLASTICA**

Ø 35 mm    Ø 1 3/8"

## 317 K

**Cod. U03170012**

**Tagliatubi per tubi in plastica**

- Per il taglio di tubi in PEX, PEHD, PVC, PER.
- Modello a cremagliera per un'azione di taglio progressiva con il minimo sforzo.
- Corpo in lega leggera.
- Esecuzione verniciata.

~~€ 49,40~~ | **€ 34,60**

Inserto in acciaio filettato per uno scorrimento rapido



Ø 3-30 mm    Ø 1/8-1 1/8"



**RAME**

## 314 C

**Cod. U03140032**

**Tagliatubi per tubi in rame e lega leggera**

- Rulli di scorrimento scanalati per il taglio di tubi bordati.
- Sostituzione rapida della rotella senza bisogno di utensili.
- Spessore massimo tubo: 2 mm.

~~€ 32,00~~ | **€ 22,40**

## 207 E FORZA D'ACCIAIO



YouTube



**L'UNICA CON STRUTTURA INTEGRALE IN ACCIAIO INOX**  
resiste alla flessione fino a 180 kg.

**SPELLAFILI INTEGRATO**



1. Spellatura.
2. Crimpatura.

**TAGLIACAVI SU ENTRAMBE LE LAME**



Adatto per cavi multipolari.

**LAMA MICRODENTATA ANTISCIVOLO**



207 E

Cod. U02070006

Forbice professionale per elettricisti

€ 34,90 | € 25,00



## 207 D

### IL RIFERIMENTO PER GLI ELETTRICISTI



**IMPUGNATURA RESISTENTE ALLA FLESSIONE FINO A 80 kg**  
in tecnopolimero caricato vetro.

50 mm<sup>2</sup>

**LAME FLUIDE E ROBUSTE**

In acciaio inox con microdentatura e tagliacavi.



**ASOLE MAGGIORATE**

207 D

Cod. U02070008

Forbice professionale per elettricisti

€ 22,90 | € 15,90



YouTube



Ø 0,02÷10 mm<sup>2</sup>



**146 B**

Cod. U01460004

Pinza spellafili  
automatica piegata a 90°

~~€ 104,00~~ | **€ 73,00**



Ø 4÷28 mm<sup>2</sup>



**163**

Cod. U01630001

Sguainacavi multifunzione

- Per il taglio circolare e longitudinale di cavi con rivestimento esterno in PVC.

~~€ 36,10~~ | **€ 25,30**



YouTube



0,5÷1 mm<sup>2</sup>  
1,5÷2,5 mm<sup>2</sup>  
4÷6 mm<sup>2</sup>



**751**

Cod. U07510002

Pinza per capicorda  
preisolati

~~€ 53,50~~ | **€ 37,50**

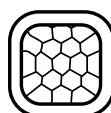

0,14÷10 mm<sup>2</sup>



Isolati

Non isolati

**753 KA**

Cod. U07530004

Crimpatrice autoregolante per  
puntalini a sezione quadra

~~€ 210,00~~ | **€ 147,00**



**9 PROFILI**

Per armadi e  
impianti tecnici



**767**

Cod. U07670001

Chiave a croce universale

~~€ 61,50~~ | **€ 43,10**

- ⊖ 1-1,2-1,5-1,8-2-2,5-3 mm
- ⊕ PH0-PH00-PH000
- ⊕ T5-T6-T7-T8-T9
- ⊕ TT10-TT15-TT20
- ⊕ PZ0-PZ1
- 0,9-1,3-1,5-2-2,5-3-4 mm
- ⊕ PT2-PT3-PT4
- PT0-PT1



**341 SH33**

Cod. U03410019

Giravite di precisione portainseri con 32 inserti

~~€ 35,10~~ | **€ 24,60**



## SMART FUNCTION

Selezione automatica della  
tensione AC/DC, resistenza  
e frequenza

MAX  
600 V

RMS



### 074 A

Cod. U00740001

#### Multimetro digitale compatto SMART

- Misurazione di AC/DC.
- Misurazioni di resistenza e continuità (suono acustico se resistenza circuito è inferiore 40 a Ω).
- Misurazioni frequenza.
- Misurazione corrente AC/DC con pinza amperometrica 076 P.



CAT III 600V

#### CARATTERISTICHE TECNICHE

Tensione continua DC	1÷600 mV÷V
Tensione alternata AC	1÷600 mV÷V
Resistenza	0÷10 Ω÷MΩ
Frequenza	3÷40 kHz
Tipo batterie (fornite)	2xAAA 1,5V

~~€ 128,00~~ | **€ 90,00**



### 007 MV

Cod. U00070035

#### Marsupio portautensili (vuoto)

- Tessuto ad altissima resistenza.
- Sistema di fissaggio alla cintura con chiusura in velcro.
- 4 tasche portautensili elasticizzate.
- Gancio porta nastro.

~~€ 17,70~~ | **€ 12,40**

Ideale sui terminali  
dell'inverter delle  
auto ibride ed  
elettriche (CEI 11-27)

MAX  
690 V



### 076 G

Cod. U00760006

#### Tester di tensione

- Rilevamento tensione/continuità.
- Identificazione fase/neutro.
- Test rotazione di fase.
- Segnalazione visiva e acustica.



#### CARATTERISTICHE TECNICHE

Tensione continua/alternata DC/AC	12÷690 mV÷V
Frequenza	50÷60 kHz
Tipo batteria (fornite)	1x9V

~~€ 117,00~~ | **€ 82,00**



### 007 MLV

Cod. U00070030

#### Marsupio portautensili con cintura (vuoto)

- Tessuto ad altissima resistenza.
- 6 tasche portautensili elasticizzate.
- Gancio porta nastro.
- Cintura regolabile da 80 a 120 cm.

~~€ 35,40~~ | **€ 24,80**

360°



## TESTA ORIENTABILE



### ALLUMINIO

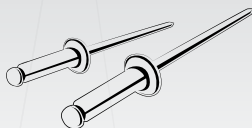

- Ø 2,4 mm  
3/32"
- Ø 3,2 mm  
1/8"
- Ø 4,0 mm  
5/32"
- Ø 4,8 mm  
3/16"

## 995 AF

Cod. U09950006

### Rivettatrice con testa orientabile

- Testa orientabile liberamente a 360°.
- Adatta a rivetti in alluminio.
- 4 testine intercambiabili.
- Corpo in lega leggera.
- Manici in materiale plastico.
- Clip in metallo per blocco apertura.
- Chiave smontaggio testine in dotazione.

~~€ 30,30~~ | **€ 21,00**



Serbatoio porta steli

### COMPATTA E POTENTE

Solo 330 mm di lunghezza  
20% di sforzo in meno rispetto al modello standard.

## 995 LA

Cod. U09950004

### Rivettatrice dritta compatta

- Modello compatto con la stessa capacità di una rivettatrice lunga standard.
- Il sistema di leve interno riduce lo sforzo dell'operatore.
- Adatta a rivetti in alluminio ed acciaio
- 5 testine intercambiabili.
- Serbatoio amovibile per recupero steli.
- Corpo in lega leggera.
- Manici in materiale plastico.

~~€ 53,50~~ | **€ 37,00**

  
**-20%  
DI SFORZO**

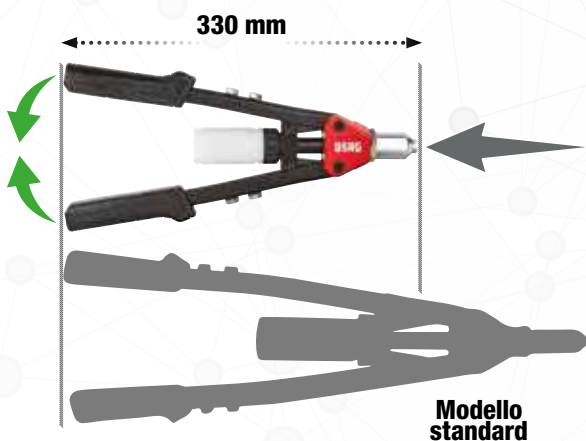

### ALLUMINIO E ACCIAIO

- Ø 2,4 mm  
3/32"
- Ø 3,2 mm  
1/8"
- Ø 4,0 mm  
5/32"
- Ø 4,8 mm  
3/16"
- Ø 6,4 mm  
1/4"



## ALLUMINIO E ACCIAIO

- Ø 2,4 mm  
3/32"
- Ø 3,2 mm  
1/8"
- Ø 4,0 mm  
5/32"
- Ø 4,8 mm  
3/16"

**SOLO  
ALLUMINIO**

### 995 A

Cod. U09950001

#### Rivettatrice

- Corpo in lega leggera.
- Leva di pressione in lamiera d'acciaio imbutita.
- Molla di richiamo per l'apertura dei manici.
- Fornita con 3 testine intercambiabili e chiave di servizio.

~~€ 28,20~~ | **€ 19,80**



## ALLUMINIO E ACCIAIO

- Ø 2,4 mm  
3/32"
- Ø 3,2 mm  
1/8"
- Ø 4,0 mm  
5/32"
- Ø 4,8 mm  
3/16"

### 926 A

Cod. U09260001



#### Rivettatrice oleopneumatica

- Fornita con quattro testine intercambiabili e chiave di servizio.

#### CARATTERISTICHE TECNICHE

Corsa	14 mm
Consumo medio aria	113 l/min
Pressione aria raccomandata	6,2 bar
Vibrazioni	1,3 m/s <sup>2</sup>
Attacco aria	1/4"
Diametro interno tubo aria	10 mm

~~€ 209,00~~ | **€ 146,00**

### 995 K

Cod. U09950005

#### Assortimento in cassetta di plastica

DESCRIZIONE	MISURA	PZ.
Rivettatrice	995 A	1
Rivetti in alluminio	995 AL/4,8x12	100
Rivetti in alluminio	995 AL/3x10	100
Rivetti in alluminio	995 AL/4x10	100
Rivetti in alluminio	995 AL/3x8	100
Rivetti in alluminio	995 AL/4x12	100

~~€ 80,50~~ | **€ 56,50**

**501**  
PEZZI



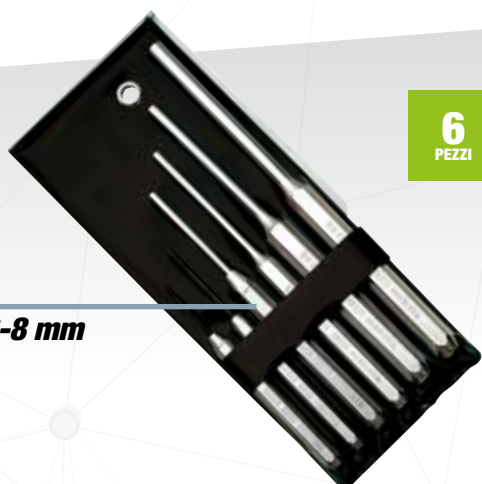

6  
PEZZI

2-3-4-5-6-8 mm

## 367 SE6

Cod. U03670081

### Serie di 6 cacciaspine

- 367/2x110-3x130-4x145-5x165-6x180-8x200 mm.
- Fornita in busta di plastica.
- Acciaio al cromo vanadio.
- Punte riportate e fosfatate per le misure da 2 e 3 mm.

~~€ 49,00~~ | **€ 34,30**



UNI 7777  
DIN 6475

Testa in acciaio al carbonio forgiata e sottoposta a trattamento termico differenziato per garantire una maggiore durata ed evitare scheggiature o ricalcature della superficie battente.

## 382

### Martelli per meccanici

- Modello tedesco a testa quadra piana e penna simmetrica.
- Manico in frassino.

CODICE	PESO TESTA	LUNGHEZZA	
U03820002	100 g	260 mm	€ 10,10   <b>€ 7,10</b>
U03820004	200 g	280 mm	€ 10,50   <b>€ 7,40</b>
U03820006	300 g	300 mm	€ 11,60   <b>€ 8,20</b>
U03820007	400 g	310 mm	€ 13,80   <b>€ 9,70</b>
U03820008	500 g	320 mm	€ 15,60   <b>€ 11,00</b>
U03820009	600 g	330 mm	€ 17,90   <b>€ 12,60</b>
U03820010	800 g	350 mm	€ 20,80   <b>€ 14,60</b>
U03820011	1000 g	360 mm	€ 23,40   <b>€ 16,40</b>
U03820013	1500 g	380 mm	€ 31,30   <b>€ 22,00</b>
U03820014	2000 g	400 mm	€ 40,60   <b>€ 28,50</b>



DIN 1041

### MATERIALI COMBINATI PER UN RISULTATO OTTIMALE.

1. Anima in grafite: massima resistenza alla flessione.
2. Elevata qualità: corpo in polipropilene che assorbe le vibrazioni.
3. Rivestimento in gomma resistente agli idrocarburi.

## 382 F

### Martelli per meccanici manico in graphite

- Modello tedesco a testa quadra piana e penna simmetrica.
- Manico in graphite.

CODICE	PESO TESTA	LUNGHEZZA	
U03820102	200 g	285 mm	€ 16,70   <b>€ 11,70</b>
U03820103	300 g	300 mm	€ 17,90   <b>€ 12,60</b>
U03820105	500 g	310 mm	€ 20,30   <b>€ 14,30</b>
U03820107	800 g	350 mm	€ 25,10   <b>€ 17,60</b>
U03820108	1000 g	355 mm	€ 27,20   <b>€ 19,10</b>



**6**  
PEZZI

## 372 SE6

Cod. U03720181

### Assortimento in busta di plastica

- Acciaio al cromo vanadio.

DESCRIZIONE	MISURA	PZ.
Scalpelli	362/125-150	2
Ugnetto	364/125	1
Punzoni	366/3x125-4x150	2
Bulini	368/4x125	1

~~€ 50,50~~ | **€ 35,40**



**UNI 7784**

## 376

### Mazzuole

- Modello a tasselli intercambiabili in materiale plastico.
- Corpo in acciaio al carbonio.
- Manico in frassino.

CODICE	Ø TASSELLI	LUNGHEZZA	
U03760001	22 mm	250 mm	€ 11,60   <b>€ 8,20</b>
U03760002	28 mm	275 mm	<del>€ 14,70</del>   <b>€ 10,30</b>
U03760003	35 mm	300 mm	€ 18,70   <b>€ 13,10</b>
U03760004	42 mm	325 mm	€ 25,20   <b>€ 17,70</b>
U03760005	50 mm	350 mm	€ 34,50   <b>€ 24,20</b>
U03760006	60 mm	380 mm	€ 50,00   <b>€ 35,00</b>

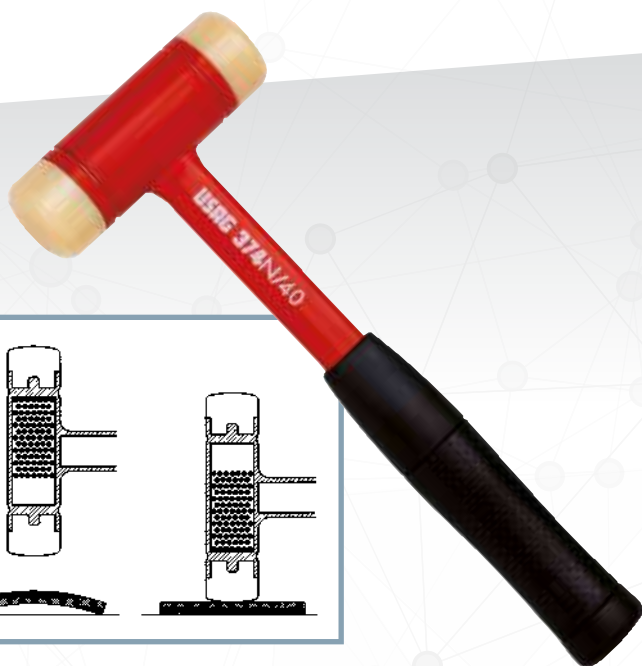

## 374 N

### Mazzuole antirimbalzo

- Modello a tasselli intercambiabili in materiale plastico.
- Corpo in acciaio al carbonio.

CODICE	Ø TASSELLI	LUNGHEZZA	
U03740004	35 mm	310 mm	€ 37,10   <b>€ 26,00</b>
U03740005	40 mm	315 mm	<del>€ 41,70</del>   <b>€ 29,20</b>
U03740006	50 mm	325 mm	€ 50,00   <b>€ 35,00</b>
U03740007	50 mm	335 mm	€ 58,50   <b>€ 41,00</b>

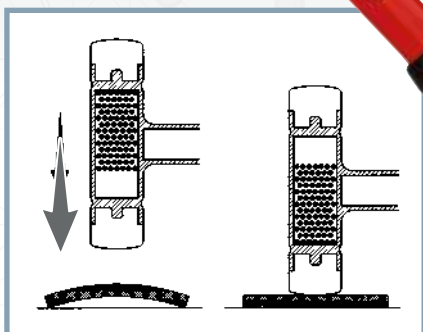

**Testa parzialmente riempita con graniglia metallica per l'assorbimento del rimbalzo**



Adatta per movimentazione lastre di vetro, marmo e lamiere metalliche



MAX  
25 kg

**424 A2**

Cod. U04240102

Ventosa manuale multiuso

~~€ 20,90~~ | **€ 14,70**

Adatta per movimentazione lastre di vetro, marmo e lamiere metalliche



MAX  
130 kg



**424 A3**

Cod. U04240103

Ventosa multiuso con impugnatura in acciaio e pompa manuale

~~€ 239,00~~ | **€ 167,00**

Fornita in valigetta



MAX  
80 kg

**424 N4**

Cod. U04240008

Ventosa per trasporto/posizionamento cristalli

~~€ 40,30~~ | **€ 28,30**

Lama intercambiabile



**424 C2**

Cod. U04240112

Raschietto per rimozione adesivi e collanti

~~€ 12,40~~ | **€ 8,70**

3 PEZZI



**987 E/S3**

Cod. U09870050

Serie di 3 spatole

• 987 E 32-50-75.

~~€ 27,50~~ | **€ 19,30**

**Lame flessibili**

3 PEZZI



**987 F/S3**

Cod. U09870051

Serie di 3 spatole

• 987 F 32-32 P-50.

~~€ 31,00~~ | **€ 21,70**

**Lame Rigide**



Capacità  
**120**  
cc

Pressione  
**413**  
bar

## Modello compatto

**421/120**

Cod. U04210000

Mini compressore a leva per grasso

~~€ 21,50~~ | **€ 15,10**

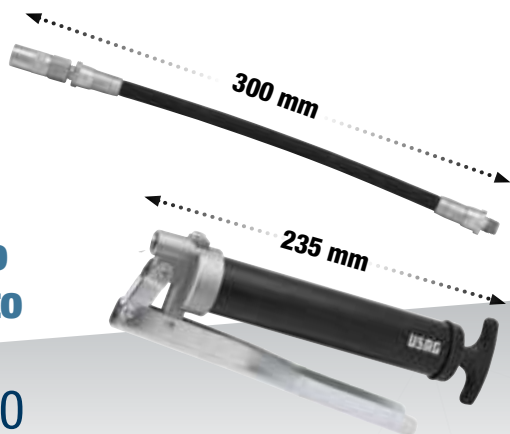

Capacità  
**500**  
cc

Pressione  
**400**  
bar

**421**

Cod. U04210002

Compressore a leva per grasso

~~€ 30,30~~ | **€ 21,30**



← 360  
↑ 50  
mm ↗ 210

**M5÷M12**

**622 K/S1**

Cod. U06220000

Assortimento per ripristino filetti

- Filettature: M5x0.8 - M6x1 - M8x1.25 - M10x1.5 - M12x1.75.
- Contiene punte in HSS-G da 13/64 - 6,3 - 21/64 - 10,3 - 31/64.

~~€ 226,00~~ | **€ 158,00**

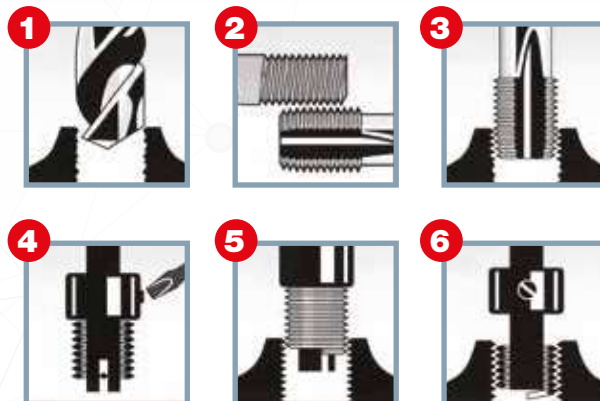

**LAMA IN  
ACCIAIO INOX**

**CORPO IN  
ALLUMINIO**

**FRANGIVETRO**



**218 N**

Cod. U02180002

Coltello multiuso

- Lunghezza lama: 72 mm.
- Lunghezza totale: 190 mm.

~~€ 30,00~~ | **€ 21,00**



## DIN 338

HSS-G

14  
PEZZI



### 988 LA/S14

Cod. U09880070

Assortimento di punte e maschi

- Ø punte: 2,5-3,3-4,2-5,0-6,8-8,5-10,2 mm.
- M maschi: 3x0,5-4x0,7-5x0,8-6x1-8x1,25-10x1,5-12x1,75 mm.

~~€ 76,00~~ | **€ 53,50**

## DIN 338

HSS-G

19  
PEZZI



### 988 MA/S19

Cod. U09880073

Assortimento di punte

- Ø punte: 1,0-1,5-2,0-2,5-3,0-3,5-4,0-4,5-5,0-5,5-6,0-6,5-7,0-7,5-8,0-8,5-9,0-9,5-10,0 mm.

~~€ 46,10~~ | **€ 32,30**

## DIN 338

HSS-G

25  
PEZZI



### 988 MA/S25

Cod. U09880074

Assortimento di punte

- Ø punte: 1,0-1,5-2,0-2,5-3,0-3,5-4,0-4,5-5,0-5,5-6,0-6,5-7,0-7,5-8,0-8,5-9,0-9,5-10,0-10,5-11,0-11,5-12,0-12,5-13,0 mm.

~~€ 91,50~~ | **€ 64,50**

HSS

3  
PEZZI



### 988 D/S3

Cod. U09880020

Serie di 3 frese a scalino

ART.	Ø SCALINI	Ø CODOLO	LUNG.
988 D1	4-5-6-7-8-9-10-11-12 mm	6 mm	65 mm
988 D2	4-6-8-10-12-14-16-18-20 mm	8 mm	75 mm
988 D3	4-6-8-10-12-14-16-18-20-22-24-26-28-30 mm	10 mm	100 mm

~~€ 169,00~~ | **€ 118,00**

HSS

12  
PEZZI



### 988 G/S12

Cod. U09880100

Serie di 10 seghe a tazza bimetalliche

- Ø 19-22-25-29-35-38-44-51-57-64 mm.
- Profondità di taglio max: 38 mm.

~~€ 173,00~~ | **€ 121,00**

HSS

10  
PEZZI



### 988 E/S10

Cod. U09880062

Frese rotative in metallo duro

- N°8 pezzi (Ø 10 e 12 forme EA-EC-EF-EG).
- N°2 pezzi (Ø 12 forme ED-EM).

~~€ 429,00~~ | **€ 199,00**





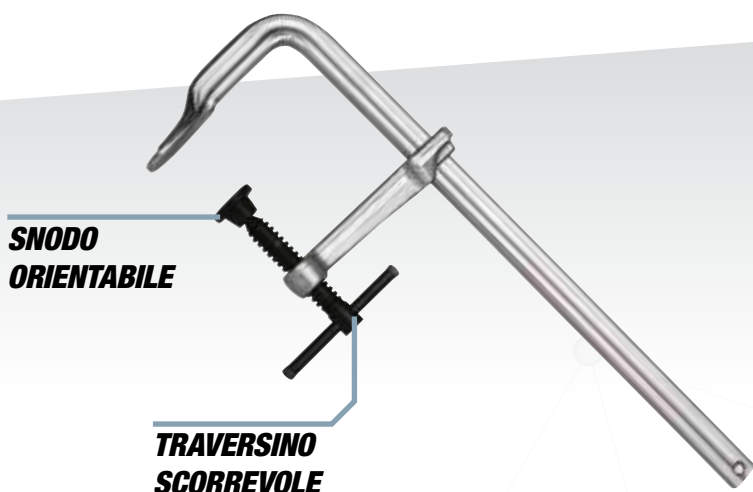

**SNODO  
ORIENTABILE**

**TRAVERSINO  
SCORREVOLE**

## 997 A

### Strettoio a vite

- Corpo e asta scorrevole in acciaio forgiato.

CODICE	APERTURA	SEZIONE	PESO	
<b>U09970002</b>	160 mm	16x7,5 mm	0,5 kg	<del>€ 24,10</del>   <b>€ 16,90</b>
<b>U09970003</b>	200 mm	19,5x9,5 mm	0,9 kg	<del>€ 30,00</del>   <b>€ 21,00</b>
<b>U09970004</b>	250 mm	22x10,5 mm	1,2 kg	<del>€ 36,00</del>   <b>€ 25,20</b>
<b>U09970005</b>	300 mm	25x12 mm	1,8 kg	<del>€ 45,90</del>   <b>€ 32,20</b>
<b>U09970006</b>	400 mm	25x12 mm	1,9 kg	<del>€ 47,90</del>   <b>€ 33,60</b>
<b>U09970007</b>	500 mm	25x12 mm	2,1 kg	<del>€ 52,00</del>   <b>€ 36,40</b>
<b>U09970008</b>	600 mm	25x12 mm	2,3 kg	<del>€ 56,50</del>   <b>€ 39,60</b>
<b>U09970009</b>	800 mm	27x13 mm	3,3 kg	<del>€ 74,00</del>   <b>€ 52,00</b>
<b>U09970010</b>	1000 mm	27x13 mm	3,7 kg	<del>€ 84,00</del>   <b>€ 59,00</b>

## 997 B

### Strettoio rapido a leva

- Regolazione e sgancio rapidi tramite leva e pulsante integrato.
- Corpo e asta scorrevole in acciaio forgiato.

CODICE	APERTURA	SEZIONE	PESO	
<b>U09970013</b>	120 mm	13,5x6,5 mm	0,7 kg	<del>€ 46,00</del>   <b>€ 32,20</b>
<b>U09970014</b>	160 mm	16x7,5 mm	1 kg	<del>€ 50,50</del>   <b>€ 35,40</b>
<b>U09970015</b>	200 mm	19,5x9,5 mm	1,3 kg	<del>€ 61,50</del>   <b>€ 43,10</b>
<b>U09970016</b>	250 mm	22x10,5 mm	1,9 kg	<del>€ 71,00</del>   <b>€ 49,70</b>
<b>U09970017</b>	300 mm	25x12 mm	2,7 kg	<del>€ 87,00</del>   <b>€ 61,00</b>
<b>U09970018</b>	400 mm	25x12 mm	2,8 kg	<del>€ 91,00</del>   <b>€ 64,00</b>
<b>U09970019</b>	500 mm	25x12 mm	3 kg	<del>€ 96,00</del>   <b>€ 67,50</b>

**PIANO  
REGOLABILE**

**LEVA CON PULSANTE  
DI SGANCIO INTEGRATO**



300 mm

**LAMA ORIENTABILE  
A 45° E 90°**

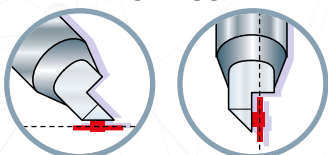

## 200 S

Cod. U02000002

### Seghetto

- Anima in acciaio rivestita in materiale plastico antiscivolo ed antiurto
- Fornito con lama al cobalto mod. 200 C24

~~€ 30,70~~ | **€ 21,50**

**SISTEMA DI TENSIONAMENTO DELLA LAMA**  
integrato nell'impugnatura



**TUTTI I PRODOTTI DELLA LINEA USAG 493 SONO FABBRICATI IN ITALIA E RISPETTANO ELEVATI STANDARD DI SICUREZZA E DURATA**

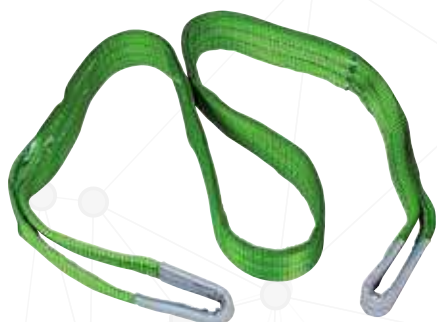

## EN 1492-1



## EN 1492-1



### 493 A

#### Fascia di sollevamento asola-asola doppio strato

- Coefficiente di sicurezza 7:1.
- Abbinamento colori e portate a norme EN 1492-1.

CODICE	PORTATA	LUNG.	€ 10,10	€ 7,10
U04930002	1 t	2 m	€ 14,90	€ 10,50
U04930003	1 t	3 m	€ 18,90	€ 13,30
U04930004	1 t	4 m	€ 23,00	€ 16,10
U04930005	1 t	5 m	€ 28,20	€ 19,80
U04930006	1 t	6 m	€ 19,40	€ 13,60
U04930012	2 t	2 m	€ 26,60	€ 18,70
U04930013	2 t	3 m	€ 33,00	€ 23,10
U04930014	2 t	4 m	€ 41,00	€ 28,70
U04930015	2 t	5 m	€ 47,90	€ 33,60
U04930016	2 t	6 m	€ 29,10	€ 20,40
U04930022	3 t	2 m	€ 40,00	€ 28,00
U04930023	3 t	3 m	€ 49,30	€ 34,60
U04930024	3 t	4 m	€ 59,50	€ 41,70
U04930025	3 t	5 m	€ 71,00	€ 49,70
U04930026	3 t	6 m		

### 493 B

#### Fune di sollevamento tonda ad anello chiuso

- Struttura con guaina rinforzata antiusura.
- Coefficiente di sicurezza 7:1.
- Abbinamento colori e portate a norme EN 1492-1.

CODICE	PORTATA	LUNG.	€ 8,35	€ 5,90
U04930052	1 t	1 m	€ 11,20	€ 7,90
U04930053	1 t	1,5 m	€ 15,80	€ 11,10
U04930054	1 t	2 m	€ 19,10	€ 13,40
U04930055	1 t	2,5 m	€ 22,90	€ 16,10
U04930056	1 t	3 m	€ 11,00	€ 7,70
U04930062	2 t	1 m	€ 16,50	€ 11,60
U04930063	2 t	1,5 m	€ 21,50	€ 15,10
U04930064	2 t	2 m	€ 27,10	€ 19,00
U04930065	2 t	2,5 m	€ 31,50	€ 22,10
U04930066	2 t	3 m	€ 15,10	€ 10,60
U04930072	3 t	1 m	€ 22,60	€ 15,90
U04930073	3 t	1,5 m	€ 28,40	€ 19,90
U04930074	3 t	2 m	€ 34,90	€ 24,50
U04930075	3 t	2,5 m	€ 41,00	€ 28,70
U04930076	3 t	3 m		



## EN 12195-2

### 493 C

#### Cinghie per ancoraggi

- Larghezza nastro 35÷50 mm.
- Tenditore a cricchetto da 35÷50 mm.
- Carico di ancoraggio 1000÷2000 N.
- Gancio ad uncino per i codici U04930102, U04930103, U04930104.
- Gancio a sponda a due dita per il codice U04930106.
- Norma di riferimento EN 12195-2.

CODICE	CARICO	NASTRO	€ 30,40	€ 21,30
U04930102	1000 N	35 mm x 4 m	€ 34,10	€ 23,90
U04930103	1000 N	35 mm x 5 m	€ 36,00	€ 25,20
U04930104	2000 N	50 mm x 8 m	€ 36,00	€ 25,20
U04930106	2000 N	50 mm x 10 m		

## SCARPE ANTINFORTUNISTICHE S1P



Made in Italy

**S1P  
SRC  
ESD**

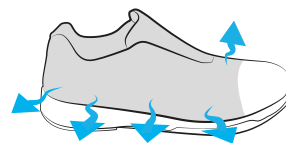

**TOMAIA  
ALTAMENTE  
TRASPIRANTE**

**CALZATA**



**100%  
METAL  
FREE**

3500 S1P

### Scarpe antinfortunistiche con tomaia traspirante

- Categoria S1P.
- Calzatura bassa in Mesh con microfibra sovrastampata.
- Fodera 100% poliestere con lavorazione a nido d'ape per migliorare il ricircolo dell'aria a vantaggio della traspirazione.
- Puntale in composito leggero e resistente.
- Soletta estraibile preformata, in poliuretano bicolore e bi-densità, traspirante, lavabile ed antibatterica. Offre

ottime performance in termini di comfort e di ammortizzamento.

- Suola in poliuretano bi-densità resistente alle flessioni ed alle abrasioni, antiolio, antiscivolo.
- Intersuola confortevole antiperforazione.
- Calzata 12.
- 100% metal free.
- Campi di impiego suggeriti: Lavori leggeri, industria meccanica, logistica/imballaggio.

~~€ 103,00~~ | **€ 60,00**

**CE EN ISO 20345: 2011**

TAGLIA	CODICE
36	U35000036
37	U35000037
38	U35000038
39	U35000039
40	U35000040
41	U35000041

TAGLIA	CODICE
42	U35000042
43	U35000043
44	U35000044
45	U35000045
46	U35000046
47	U35000047

## MID 2014/32/UE



981 A

### Flessometri professionali con rivestimento antiurto

- Classe di precisione II.
- Cassa in ABS con rivestimento antiurto.

CODICE	L	NASTRO	SCALA	
U09810036	3 m	19 mm	mm	€ 9,15   <b>€ 5,90</b>
U09810037	5 m	28 mm	mm	€ 15,60   <b>€ 8,40</b>
U09810038	8 m	28 mm	mm	€ 18,20   <b>€ 11,90</b>



984 MN

### Livelle in alluminio con base magnetica

- Corpo in Alluminio verniciato con base d'appoggio rettificata.
- Fiale infrangibili (garanzia 5 anni).
- Liquido fluorescente, insensibile a temperature da -50° a +50° C.

CODICE	L	BASE	PRECISIONE	
U09840024	300 m	22 mm	0,057° = 1 mm/m	€ 25,60   <b>€ 18,00</b>
U09840025	400 m	22 mm	0,057° = 1 mm/m	€ 27,30   <b>€ 19,10</b>
U09840026	500 m	22 mm	0,057° = 1 mm/m	€ 33,10   <b>€ 23,20</b>



- SMD LED
- IP20
- Lampada: 5 h  
Torcia: 9 h
- 4,5 h
- IK07
- Li-ion

## 889 RD

Cod. U08890035

Lampada di ispezione a LED

~~€ 97,50~~ | **€ 68,00**



YouTube

### DOPPIA FUNZIONE



LAMPADA



TORCIA

RICARICABILE



- COB LED
- IP54
- 2,5/5 h
- 4 h
- IK06
- Li-Poly

## 889 SA

Cod. U08890019

Lampada ispezione a LED extra sottile ad alta luminosità

~~€ 115,00~~ | **€ 80,00**



YouTube



RICARICABILE

USB



- SMD LED
- 2/5 h
- Li-ion
- IP54
- 6 h

## 889 TR

Cod. U08890073

Torcia LED in alluminio ricaricabile

~~€ 65,50~~ | **€ 45,90**



RICARICABILE

USB

360°



- Lampada COB LED
- Torcia SMD LED
- Lampada: 3h  
Torcia: 10h
- IP20
- 4,5 h
- Li-ion

**889 RP**

Cod. U08890045

Lampada a LED ricaricabile compatta

~~€ 58,50~~ | **€ 41,00**



YouTube

## DOPPIA FUNZIONE



LAMPADA



TORCIA

RICARICABILE USB



YouTube

180°



- COB LED
- IP67
- 2,5 h
- 1 = 8 h  
2 = 4 h  
3 = 2,5 h
- IK07
- Li-ion

**889 RT**

Cod. U08890038

Faretto a LED ricaricabile - certificato IP67

~~€ 253,00~~ | **€ 177,00**

## 3 LIVELLI DI LUMINOSITÀ



500, 1000 e 1500 lumen con un semplice tocco.

**FUNZIONA CON O SENZA CAVO!**

Cavo da 5 metri incluso.



- COB LED
- IP54
- 24/6,5 h
- 3xAAA

**889 LTE**

Cod. U08890014

Lampada frontale a LED

~~€ 55,50~~ | **€ 29,90**



ORIENTABILE



CINTURINO ANTISCIVOLO



SENSORE DI MOVIMENTO



## MANUTENZIONE AUTO IBRIDE ED ELETTRICHE LE OPERAZIONI PRINCIPALI PER L'AUTOFFICINA:



### MESSA IN SICUREZZA

Escludere la tensione dell'impianto elettrico per poter effettuare la manutenzione del veicolo.



### MANUTENZIONE CELLE BATTERIE

Sostituire le singole celle usurate per ricondizionare il pacco batterie.



### LO SAPEVI CHE...

- A.** Auto ibride ed elettriche montano impianti elettrici con **tensioni elevate e potenzialmente pericolose (oltre 200 V in CC e 600 V in CA)**.
- B.** Gli interventi di manutenzione su auto ibride ed elettriche sono equivalenti a **lavori elettrici su sistemi di categoria 0 e 1**, come definito nel D. Lgs 81/08 - normativa tecnica di riferimento CEI 11-27.
- C.** È necessario utilizzare attrezzatura **con isolamento 1000 V come: utensili, guanti, sovraguanti e tappetino** per garantire la sicurezza durante le operazioni.



## IL NECESSARIO PER LA MESSA IN SICUREZZA

**NEW**



8  
PEZZI

3  
8"

↔ 435  
↑ 70  
mm ↘ 270

**098 3/8" HYB8**

Cod. U00980508



**Assortimento in cassetta di ABS per MESSA IN SICUREZZA AUTO IBRIDE ed ELETTRICHE**

- Cassetta in ABS ad alta resistenza con sistema di chiusura rapida.

DESCRIZIONE	ART./MISURA	PZ.
Chiavi a bussola con bocca poligonale 1000 V	098 3/8" 8-10-12	3
Cricchetto reversibile 1000 V	098 A 3/8"	1
Prolunga 1000 V	098 B 3/8" 150	1
Pinza 1000 V	081 EX 200	1
Giravite per viti a intaglio 1000 V	091 1x5,5x125	1
Giravite per viti a impronta PHILLIPS® 1000 V	091 PH 2x125	1

~~€ 317,50~~ | **€ 239,00**

**NEW**

## ASSORTIMENTO PER MESSA IN SICUREZZA E MANUTENZIONE CELLE BATTERIE!



519 M 098HYB8

519 M 098HYB11

076 G

20  
PEZZI



**495 098HYB**

Cod. U04958010

**Assortimento per MESSA IN SICUREZZA e MANUTENZIONE CELLE BATTERIE - 1 cassetto**

DESCRIZIONE	ART	PZ
Bussole poligonali 1000 V (8-10-12 mm), cricchetto 1000 V (098 A 3/8), prolunga 3/8" 1000 V, giraviti 1000 V e pinza 1000 V	519 M 098HYB8	8
Bussole poligonali 1000 V (11-13-14 mm), chiavi poligonali 1000 V (8-10-12-13-14 mm) e giraviti 1000 V	519 M 098HYB11	11
Tester di tensione	076 G	1

~~€ 765,00~~ | **€ 499,00**



**5 CASSETTI  
3 MODULI**



**NEW**

20  
PEZZI



**516 SP5HYA-S**

Cod. U05168024

**Carrello START per MESSA IN SICUREZZA e MANUTENZIONE CELLE BATTERIE - 1 cassetto**

DESCRIZIONE	ART	PZ
Bussole poligonali 1000 V (8-10-12 mm), cricchetto 1000 V (098 A 3/8), prolunga 3/8" 1000 V, giraviti 1000 V e pinza 1000 V	519 M 098HYB8	8
Bussole poligonali 1000 V (11-13-14 mm), chiavi poligonali 1000 V (8-10-12-13-14 mm) e giraviti 1000 V	519 M 098HYB11	11
Tester di tensione	076 G	1

~~€ 1.331,00~~ | **€ 879,00**



## NUOVI AVVIATORI PORTATILI

### TRASFORMATORE INTEGRATO

Nessun alimentatore esterno.



**BATTERIA AGM**  
(Absorbed Glass Mat)

12 V

1200 A



**3500 A**

**LUNGHEZZA CAVI 155 cm**

### PULSANTE TEST

Indicazione semaforica a LED dello stato di carica della batteria.

**NEW**



YouTube

**1613 RA12**

Cod. U16130019

**Avviatore portatile 12V**

- Scocca antiurto in ABS.
- Idoneo anche per batterie sigillate.
- Pinze diritte.
- Fornito con cavo di ricarica.

~~€ 504,00~~ | **€ 350,00**



**VANO PER CAVO RICARICA E ACCENDISIGARI**



**FUSIBILE ESTERNO**

Protezione da sovracorrente fino a 300A. Facile da sostituire in caso di sovraccarico.

### CONNETTORE POSTERIORE PER SELEZIONE VOLTAGGIO



**BATTERIA AGM**  
(Absorbed Glass Mat)

12 V  
24 V

1400 A  
700 A



**12V - 3700 A**

**24V - 1860 A**

**LUNGHEZZA CAVI 155 cm**

### FUSIBILE ESTERNO

Protezione da sovracorrente fino a 300A.

**NEW**

**1613 AGM 12-24**

Cod. U16130013

**Avviatore professionale portatile 12V-24V**

- Scocca antiurto in ABS.
- Protezione da sovratensione.
- Idoneo anche per batterie sigillate.
- Pinze inclinate.
- Fornito con caricatore di rete e cavo presa accendisigari.

~~€ 1.142,00~~ | **€ 799,00**



**VOLTMETRO**

per indicazione dello stato di carica della batteria interna.



## PER BATTERIE 6÷12 V

Anche per sistema  
Start & Stop



890 K

Cod. U08901000

Tester digitale per batterie con stampante

~~€ 603,00~~ | **€ 422,00**

## E-OBD OBD-II

**⚠ IMPORTANTE ⚠**

Utilizzare questo accessorio  
solo con avviatori da 12V.



1613 OBD

Cod. U16130003

Cavo OBD salva-memorie 12 V

~~€ 47,10~~ | **€ 33,00**

12 V

12 V



1612 BA12

Cod. U16120006

Proteggi centraline 12 V

- Protegge le centraline durante le operazioni di saldatura, avviamento con caricabatterie o avviatori, avviamento con cavi.

~~€ 74,50~~ | **€ 52,00**

24 V



1612 BA24

Cod. U16120007

Proteggi centraline 24 V

- Protegge le centraline durante le operazioni di saldatura, avviamento con caricabatterie o avviatori, avviamento con cavi.

~~€ 74,50~~ | **€ 52,00**

Range di misura: -60÷625°  
Rapporto ottico: 16:1



Compatibile  
con termocoppia K.



YouTube



1651

Cod. U16510001

Termometro digitale ad infrarossi

~~€ 162,00~~ | **€ 113,00**



22  
PEZZI



1881 S22

Cod. U18810082

Kit universale per lo smontaggio e il montaggio  
delle ghiera pulegge alternatori

- Fornito in cassetta di plastica

~~€ 120,00~~ | **€ 84,00**

## KIT UNIVERSALE PER LA RIMOZIONE DI DADI E VITI ANTIFURTO



10  
PEZZI

**272 DS**  
Cod. U02720001

### Kit estrazione dadi e viti antifurto

- Non danneggia il cerchio in lega.
- Punte speciali al carburo di tungsteno in grado di forare qualsiasi tipo di materiale (lubrificare con olio da taglio ad ogni utilizzo).
- Bussole coniche per centraggio/estrazione super sottili per accedere su ogni tipo di cerchio in lega.

~~€ 273,00~~ | **€ 190,00**

YouTube  
**VIDEO  
TUTORIAL**



**ESTRATTORE PROGETTATO  
PER RESISTERE 150 Nm:  
IDEALE PER VITI BMW.**

Dadi e viti antifurto standard:  
**svita velocemente con  
le bussole coniche.**



Dadi e viti con anello girevole:  
**fora ed estrai in sicurezza  
con gli utensili speciali.**



**447 T**  
Cod. U04470101

### Smonta ammortizzatori pneumatico

- Ideale per autovetture.
- Sistema di autolivellamento dei bracci superiori: adatto anche a molle coniche e disassate.
- Boccole autolubrificanti: nessuna operazione di lubrificazione e/o ingrassaggio sulle colonne di scorrimento.
- Fornito con due staffe inferiori 447 TC1 (78÷130 mm) e 447 TC2 (105÷182 mm), morsa 447 TA e morsetti superiori universali 447 TB1.



YouTube

**POTENZA DI  
COMPRESSIONE**  
**735 kg (6 bar),  
1226 kg (10 bar).**

#### CARATTERISTICHE TECNICHE

Potenza compressione	735 kg (6 bar) - 1226 kg (10 bar)
Pressione di esercizio	6÷10 bar
Corsa del pistone	420 mm
Cilindro	Doppio in lega d'alluminio e resina al nylon



~~€ 1.705,00~~ | **€ 1.179,00**

## CONFORMITÀ ALLA DIRETTIVA MACCHINE

Gli smontammortizzatori pneumatici USAG sono progettati per rispondere pienamente alla Direttiva Macchine 2006/42/CE. Alcune funzionalità della macchina sono state impostate perché l'operatore possa lavorare in totale sicurezza:

- Protezione frontale di sicurezza.
- Dispositivo di arresto del pistone in caso di apertura della protezione frontale.
- Velocità limitata: sempre inferiore ai 10 cm/sec.
- Sistema di blocco delle ganasce e del pistone in caso di interruzione dell'alimentazione dell'aria.



3  
PEZZI

1 1/2"

**270 C/C3**  
Cod. U02700106

Assortimento in cassetta modulare con bussole macchina per cerchi in lega con protezione in teflon

~~€ 51,00~~ | **€ 35,70**

← 190  
↑ 58  
mm ↗ 144

17 19 21

**NEW**

1 1/2"

19,35 mm



Mercedes-Benz

80 mm

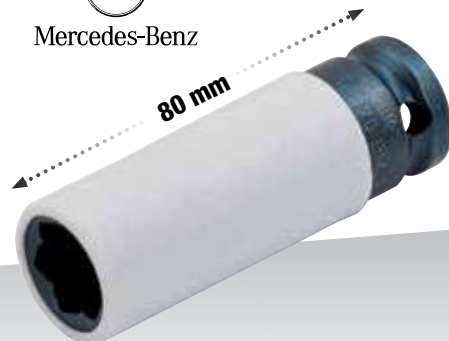

**270 BM**  
Cod. U02700140

Chiave a bussola per dadi ruota Mercedes

- Adatta per i modelli: Classe C e GLK (W204), Classe E (W211, W212, W207), Classe SLK (W172), Classe ML (W164, W166), Classe CL (W216), Classe S (W221, W222).

~~€ 11,90~~ | **€ 8,40**



### RIVESTIMENTO PROTETTIVO

Lo speciale rivestimento in teflon riduce il rischio di danneggiamento quando si opera su cerchi in lega di alluminio.



### CODICE COLORE

ogni misura è facilmente riconoscibile grazie al colore del rivestimento in teflon.



10  
PEZZI



YouTube



**425 TPMS**  
Cod. U04250005

1,2 kg | 360 mm | 65 mm | 160 mm

Kit di utensili per montare e smontare le valvole pneumatici con sistema di controllo della pressione

~~€ 267,00~~ | **€ 187,00**



**1,4÷10 Nm**

Universale per tutti i tipi di valvole TPMS

**CEE 86/217**

SCALA GRADUATA  
in bar/psi



**927 MN**  
Cod. U09270003

Pistola di gonfiaggio con manometro

~~€ 79,50~~ | **€ 56,00**

**NEW**

## 236 K per bussole



**MASSIMA ACCESSIBILITÀ**  
DIMENSIONI TESTA COME UN  
CRICCHETTO\*.



**39 mm**

\*Confronto con cricchetto da 1/2".



YouTube

## 236 KE per inserti



**MINIMO INGOMBRO**  
INNESTO DIRETTO PER  
INSERTI MACCHINA.



Anello di tenuta  
in acciaio integrato.



YouTube

## UTILIZZABILI CON CRICCHETTO O AVITATORE

**BUSSOLE**



### 236 K

Prolunga a catena in alluminio per bussole

CODICE	□	L	H	📦
--------	---	---	---	---

U02360700 1/2" 340 mm 39 mm 1,1 kg € 101,00 | **€ 70,00**

U02360698 1/4" 260 mm 27 mm 300 g € 76,00 | **€ 50,00**



**13**  
PEZZI



### 236 K/C13

Cod. U02360852



Assortimento in cassetta modulare  
con bussole esagonali macchina

~~€ 242,50~~ | **€ 170,00**

3 kg | mm | 435  
70  
270

**INSERTI**



### 236 KE

Prolunga a catena in alluminio per inserti

CODICE	□	◇	L	H	📦
--------	---	---	---	---	---

U02360705 1/2" 1/2" 340 mm 24 mm 1,1 kg € 101,00 | **€ 70,00**

U02360710 1/4" 1/4" 260 mm 19 mm 300 g € 76,00 | **€ 50,00**



**NEW**



**18**  
PEZZI



**NEW**

### 236 KE/C18

Cod. U02360890



Assortimento in cassetta  
modulare con inserti macchina

~~€ 350,50~~ | **€ 170,00**

3 kg | mm | 435  
70  
270

## PRESSIONE REGOLABILE FINO A 4 BAR



### Fornito con:

- guarnizioni di ricambio,
- 1 tappo multidiametro 44-45-46 mm (2847 N11).
- 1 contenitore di recupero olio.

### 2847/3

Cod. U28470084

### 12 V

#### Spurgatore per circuito freni

- Permette di cambiare, riempire, spurgare i circuiti dei freni di autovetture e veicoli industriali.
- Apparecchio progettato esclusivamente per liquidi freno tipo DOT 3, DOT 4, DOT 5.1. No LHM.
- Pressione regolabile fino a 4 bar.
- Arresto automatico al 10% del serbatoio (1 L).
- Alimentazione 12 V tramite cavi batteria.
- Vano posteriore accessori.
- Ruote integrate e maniglione per un facile trasporto.

~~€ 1.346,00~~ | **€ 942,00**

#### CARATTERISTICHE TECNICHE

Sistema di manovra del liquido	Pompa peristaltica (nessun contatto diretto pompa liquido, nessuna pressione aria sul liquido)
Alimentazione	12 V (morsetti batteria)
Capacità serbatoio	10 litri
Limitatore di pressione	4 bar
Tubo a spirale	4 m (elastico)
Cavo di alimentazione	4 m



### 2847 N4

Cod. U28470098Q

#### Tappo adattatore universale

- Per spurgafreni 2847/3.

~~€ 150,00~~ | **€ 109,00**



**21**  
PEZZI

### 2800 S21

Cod. U28000085

#### Kit di 21 utensili per pistoncini freni

- Compatibile con i seguenti modelli d'auto: Citroen, Audi, Fiat/Alfa Romeo, Ford, Isuzu, Honda, Jaguar, Bmw, Mercedes, Mitsubishi, Nissan, Rover, Toyota, Volvo, Volkswagen, Mazda, Saab, Gm, Subaru, Peugeot, Renault, Mini, Opel.

~~€ 155,00~~ | **€ 109,00**



**6**  
PEZZI

**1 1/2"**

**NEW**

**14-16-18**

### 233 1/2" MXZN/C6

Cod. U02332513



#### Assortimento in cassetta di ABS con bussole macchina XZN corte e lunghe

- Ideale per pinze freno VW Touareg (asse posteriore) oppure per Mercedes Atego (truck).
- 233 1/2 MXZN/14-16-18-14L-16L-18L.

~~€ 92,60~~ | **€ 65,00**

## 443 N CHIAVE AUTOMATICA PER FILTRI OLIO

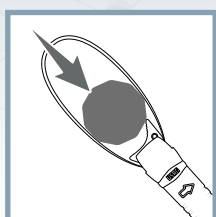

**SERRAGGIO AUTOMATICO  
DEL NASTRO**

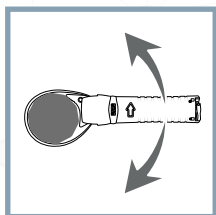

**EFFETTO CRICCHETTO**  
Rapidità d'uso anche in spazi ridotti.

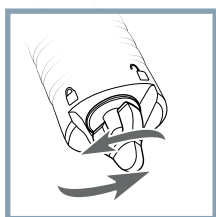

**LEVA DI INCREMENTO  
POTENZA SERRAGGIO**



YouTube



**443 N**

**66÷105 mm**



**Cod. U04430005**

Chiave automatica a ripresa rapida per  
filtri olio (autovetture)

~~€ 91,00~~ | **€ 64,00**

**443 NC**

**106÷150 mm**



**Cod. U04430007**

Chiave automatica a ripresa rapida per  
filtri olio (veicoli industriali)

~~€ 105,00~~ | **€ 73,50**



60÷80 mm

80÷100 mm



YouTube

**446 E/SE2**

**Cod. U04460015**



Serie di 2 chiavi autoserranti per filtri olio  
• 446 E/60÷80-80÷100 mm

~~€ 143,00~~ | **€ 100,00**

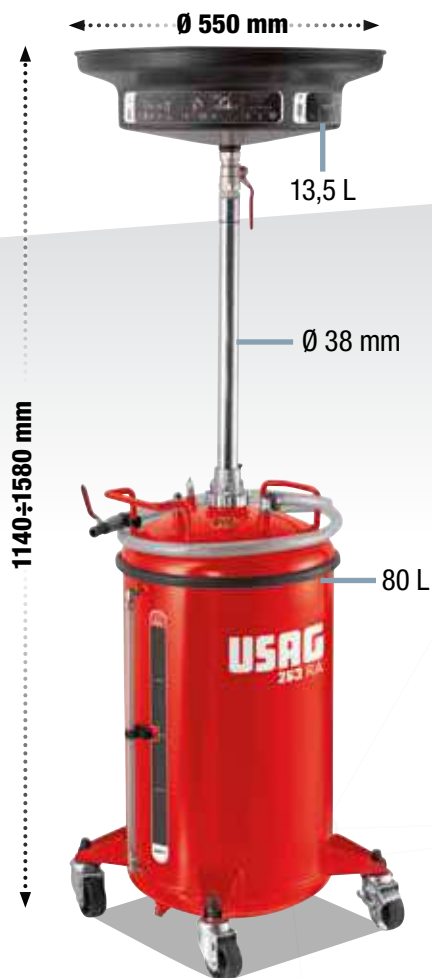

**80**  
Litri



## 263 RA

Cod. U02631600

### Recuperatore olio

- Modello a caduta.
- Indicatore laterale per la verifica del livello olio nel serbatoio.
- Griglia in materiale plastico all'interno della coppa.
- Sistema di svuotamento del serbatoio con aria compressa (max 3,5 bar).
- Tubo di scarico flessibile lungo 1800 mm.
- 4 ruote pivotanti:  $\varnothing$  70 mm.

~~€ 531,00~~ | **€ 290,00**



**Compatibile con  
liquido freni DOT  
ed antigelo**



Tubo esterno antiurto  
in poliuretano per il  
controllo del serbatoio



Blocco di giunzione in  
metallo con guarnizione  
interna in EPDM

Attacco per il  
recuperatore d'olio



**16**  
PEZZI



## 263/S16

Cod. U02631400

### Kit per tappi olio

- Bussole magnetiche.
- 1 chiave snodata con coppetta.
- 2 inserti  $\varnothing$  8-10 mm.
- 6 inserti  $\varnothing$  8-10-12-13-14-17 mm.
- 6 bussole  $\varnothing$  13-14-17-18-19-21 mm.
- 1 inserto  $\varnothing$  T45.

~~€ 164,00~~ | **€ 115,00**

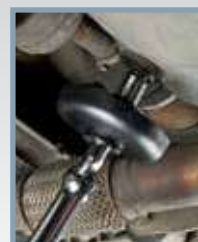

**VASCHETTA  
RACCOGLI OLIO  
INTEGRATA**



## 263 VAG

Cod. U02631150

### Bussola per tappi olio Audi e Volkswagen

- Quadro di manovra: 3/8"
- Per lo svitamento e la rimozione dei nuovi tappi olio in plastica montati su tutte le nuove vetture Audi e Volkswagen
- Utilizzabile sui seguenti modelli di auto:
  - Audi A1, A3, A4, A5, A6, A7, Q3, Q5, Q7, TT, TTS
  - Seat Alhambra, Leon, Toledo
  - Skoda Octavia, Rapid, Superb, Yeti
  - Volkswagen Maggiolino, Caddy, CC, Golf, Jetta, Passat, Polo, Scirocco, Sharan, Tiguan, Touran

~~€ 15,50~~ | **€ 10,90**



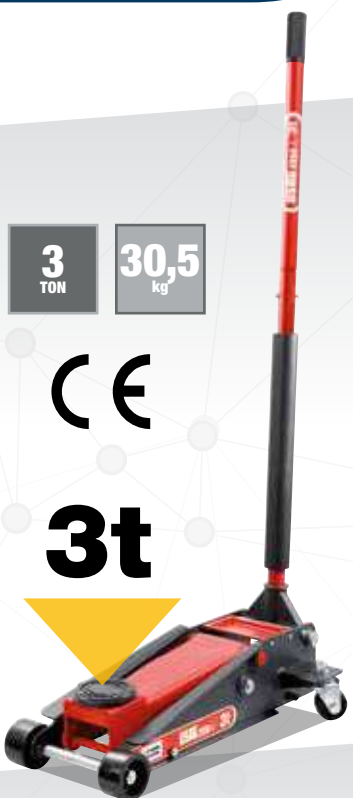

**3**  
TON

**30,5**  
kg

CE

**3t**

## 2550 A

Cod. U25500001

**Sollevatore idraulico 3T per auto e veicoli commerciali**

- Struttura in acciaio.
- Polivalente e compatto.
- Portata elevata per utilizzo su auto, fuoristrada e furgoni.
- Sistema a doppia pompa per sollevare più velocemente la vettura.
- Dotato di comando di discesa manuale.
- Valvola di spurgo dell'aria, per evitare il pericolo di over-carico.
- Impugnatura con gomma antiurto.
- Ruote in poliuretano.

~~€ 297,00~~ | **€ 199,00**



**COMPATTO**

615 mm di lunghezza.



133÷465  
mm

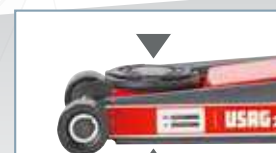

**Sottile**

75 mm di altezza.



75÷505  
mm



**2**  
TON

**32,5**  
kg

CE

**2t**

## 2550 B

Cod. U25500002

**Sollevatore idraulico 2T**

- Struttura in acciaio.
- Per utilizzo in spazi ridotti.
- Sistema a doppia pompa per sollevare più velocemente la vettura.
- Dotato di pedale di avvicinamento.
- Dotato di comando di discesa manuale.
- Valvola di spurgo dell'aria, per evitare il pericolo di over-carico.
- Impugnatura con gomma antiurto.
- Ruote in poliuretano.

~~€ 419,00~~ | **€ 295,00**



**Pedale di avvicinamento**



## 1950 C

**Coppia colonnette**

- Altezza regolabile tramite meccanismo dentato con rilascio a leva.
- Perno di bloccaggio con catena.
- 1950 C/3: modello regolabile a 10 posizioni.
- 1950 C/6: modello regolabile a 13 posizioni.

CODICE	PORTATA	H MAX	H MIN	DIMENSIONI	PESO
U19501001	3 t	427 mm	300 mm	207x188 mm	7 kg
U19501002	6 t	620 mm	400 mm	285x250 mm	14 kg

€ 82,50 | **€ 58,00**

€ 119,00 | **€ 83,50**





**2 in 1**

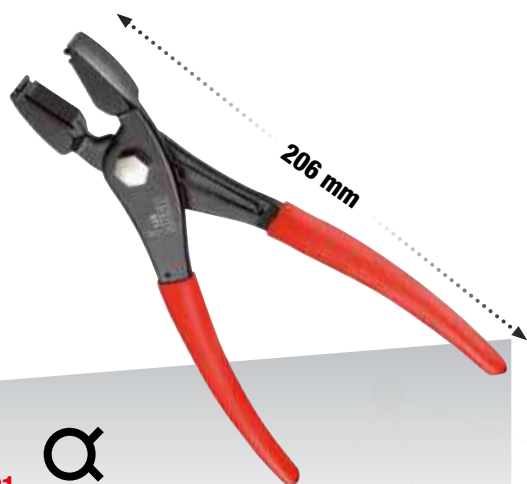

**871 D**

Cod. U08710001



**Pinza per anelli stringitubo a presa frontale/laterale**

- Possibilità di aggancio frontale o laterale.
- Ganasce con superficie di presa zigrinata.

~~€ 47,30~~ | **€ 33,20**

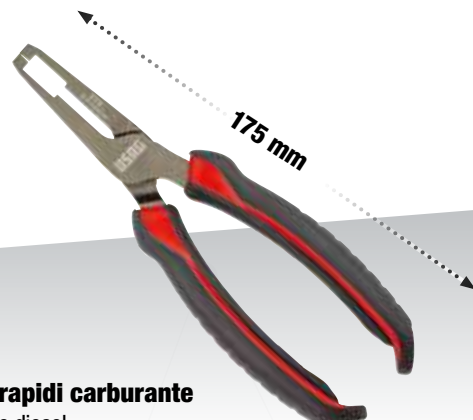

**870 C**

Cod. U08700006

**Pinza per raccordi rapidi carburante**

- Per veicoli a benzina e diesel.
- Impugnature ergonomiche bimalteriali.

~~€ 57,00~~ | **€ 39,90**

3 posizioni  
di lavoro

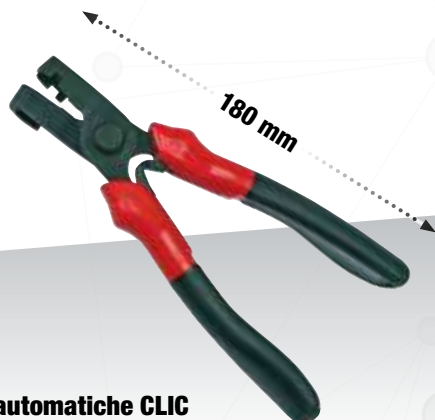

**871 C**

Cod. U08719005P

**Pinza per fascette automatiche CLIC**

- Testa triassiale per lavorare in tutte le posizioni.
- Permette di aprire o chiudere le fascette automatiche presenti sui circuiti del carburante, dei collettori d'aspirazione e dei circuiti idraulici.

~~€ 67,00~~ | **€ 46,90**



**468 M**

**Utensile a percussione per anelli di tenuta e guarnizioni**

- Semplifica l'inserimento di anelli di supporto esterni per cuscinetti obliqui.
- Asse, sede dei cuscinetti e anelli di tenuta non vengono danneggiati.
- Ghiera regolabile in 3 posizioni.
- Impugnatura in acciaio.

CODICE	CAPACITÀ	LUNGHEZZA	
U04680150	9,5÷50 mm	176 mm	€ 89,50   <b>€ 63,00</b>
U04680151	18÷90 mm	210 mm	€ 112,00   <b>€ 78,50</b>

**9**  
PEZZI

Due spazzole metalliche  
Ø 20mm e 25mm



**885 F**

Cod. U08850004

**Kit pulizia iniettori**

- Ideale per la pulizia del condotto degli iniettori montati su motori common rail.

~~€ 149,00~~ | **€ 104,00**

**6**  
PEZZI

**1/2"**



**884 C/S6**

Cod. U08841000

**Serie di 6 chiavi per raccordi tubi iniettori**

- Per montaggio/smontaggio dei raccordi tubi iniettori.
- Lunghezza: 98 mm.
- Misure: 12-14-16-17-18-19 mm.

~~€ 112,00~~ | **€ 78,50**

12  
PEZZI

**UNIVERSALE  
PER AIRBAG**



**426 SAB**

Cod. U04260010

**Kit manutenzione Airbag**

- Adatto per i seguenti modelli di auto: VW Bora, Golf 4, Jetta, Lupo, New Beetle, Passat B5, Polo; Audi A4, A6; BMW; Mercedes-Benz; Opel; Renault; Seat; Skoda Fabia, Octavia, Superb.

~~€ 69,00~~ | **€ 48,30**

4  
PEZZI

Per la rimozione di  
contrappesi, silicone,  
modanature etc



**426 C/S4**

Cod. U04260007

**Kit di 4 raschietti multiuso in plastica**

~~€ 29,60~~ | **€ 20,80**

4  
PEZZI

Per separare i carter della  
cinghia di distribuzione,  
testata motore, cinghia di  
trasmissione etc.



**426 D/S4**

Cod. U04260005

**Kit di 4 scalpelli separatori in plastica**

~~€ 23,70~~ | **€ 16,60**

5  
PEZZI

Per la rimozione di  
modanature, pioli, parti  
di cruscotto, rivestimenti  
portiere, etc.



**426 B/S5**

Cod. U04260006

**Kit di 5 utensili per componenti in plastica**

~~€ 27,70~~ | **€ 19,40**

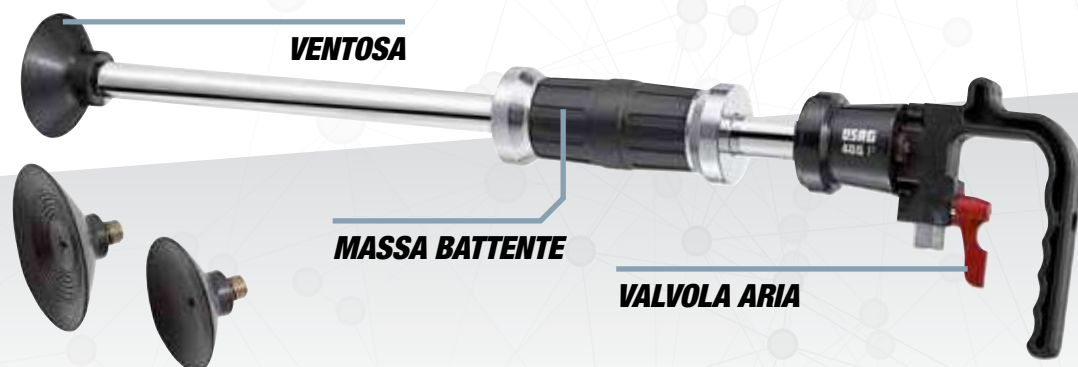

**CARATTERISTICHE TECNICHE**

Attacco filettatura	M18
Livello sonoro	78 Db
Lunghezza totale	610 mm
Peso	4 Kg
Pressione di esercizio	6,2 bar
Attacco filettato	1/4"

**400 P**

Cod. U04000010

**Aspiratore pneumatico ammaccature**

- Ideale per eliminare ammaccature da parti sciolate senza la necessità di rivernicare.
- Fornito con 3 ventose (Ø 75-100-125 mm), in valigetta in materiale plastico dotata di maniglia per il trasporto e clip di chiusura.

~~€ 178,00~~ | **€ 125,00**



**9,5**

Litri



4,1 kg | 230 mm | 627 mm | 302 mm

**1785 B**

**Cod. U17850005**

**Aspiratore liquidi manuale e pneumatico**

**CARATTERISTICHE TECNICHE**

Pressione aria raccomandata	5÷8 bar
Range temperatura liquidi aspirati	1÷100 °C
Capacità serbatoio	9,5 litri
Accessori contenuti	1 tubo principale 1500 x Ø 16 mm - 4 tubi di aspirazione: 400 x Ø 9,5 mm, 700 x Ø 6 mm, 850 x Ø 7, 700 x Ø 6

~~€ 200,00~~ | **€ 140,00**



4,6 kg | 1.030 mm | 480 mm | 115 mm



**2000 A**

**Cod. U20000100**

**Letto sottoscocca 6 ruote**

- Cuscino poggiatesta in vinile resistente agli idrocarburi.
- Struttura in materiale plastico resistente agli idrocarburi, lavabile.
- Due vaschette porta utensili laterali.
- Altezza massima da terra: 115mm.
- Fornito con 6 ruote in gomma pivotanti Ø 80mm (da montare).

~~€ 107,00~~ | **€ 75,00**

**250**  
**coprisedili**



**3781 E**

**Cod. U38000075**

**Coprisedili**

- In polietilene
- In formato doppio, riveste tutto il sedile compresa la parte posteriore
- Spessore: 13 micron
- Dimensioni: 70x165 cm

~~€ 104,00~~ | **€ 75,00**

**250 tappetini**

**1 bobina**  
**coprivolante**

**250 coprisedili**



**3781 A**

**Cod. U38000072**

**Set service**

- Fornito con espositore murale.

~~€ 373,00~~ | **€ 199,00**

**3781 C**

**Cod. U38000073**

**Tappetino per officina**

- Salvamoquette in carta di tipo assorbente
- Dimensioni: 45x35 cm

~~€ 103,00~~ | **€ 75,00**



**3781 D**

**Cod. U38000074**

**Coprivolante**

- Per la protezione del volante durante la permanenza del veicolo in officina
- Materiale: film estensibile
- Dotate di srotolatore in plastica

~~€ 46,90~~ | **€ 29,00**



## ILLUMINAZIONE A LED

1.898 Nm  2,2 kg



 YouTube

## CARTER IN LEGA DI MAGNESIO



## TOP DI GAMMA

943 PC1 1/2"   
Cod. U09430001

Avvitatore ad impulsi in magnesio

~~€ 439,00~~ | **€ 299,00**

### CARATTERISTICHE TECNICHE

Attacco quadro	1/2"	Pressione aria raccomandata	6,2 bar
Capacità bullone	M20	Pressione sonora	94 ±3 dB(A)
Coppia massima	1.898 Nm	Potenza sonora	105 ±3 dB(A)
Coppia di lavoro	320÷460 Nm	Vibrazioni	6,4 m/s <sup>2</sup>
Impulsi al minuto	1200	Attacco aria	1/4"
Velocità a vuoto	6.500 giri/min	Diametro interno tubo aria	10 mm
Consumo medio aria	172 l/min	Peso	2,2 kg

## CARTER IN LEGA DI MAGNESIO

1.600 Nm  2 kg



 YouTube



## IL RIFERIMENTO

929 PC1 1/2"   
Cod. U09290001

Avvitatore ad impulsi in magnesio

~~€ 338,00~~ | **€ 230,00**

### CARATTERISTICHE TECNICHE

Attacco quadro	1/2"	Pressione aria raccomandata	6,2 bar
Capacità bullone	M16	Pressione sonora	93 ±3 dB(A)
Coppia massima	1.600 Nm	Potenza sonora	104 ±3 dB(A)
Coppia di lavoro	280÷440 Nm	Vibrazioni	6,2 m/s <sup>2</sup>
Impulsi al minuto	1.300	Attacco aria	1/4"
Velocità a vuoto	7.000 giri/min	Diametro interno tubo aria	10 mm
Consumo medio aria	172 l/min	Peso	2,0 kg

11 cm



## EXTRA COMPATTO

861 Nm  1,3 kg



 YouTube

942 PC3 1/2"   
Cod. U09420012

Avvitatore ad impulsi - extra compatto

~~€ 218,00~~ | **€ 159,00**

### CARATTERISTICHE TECNICHE

Attacco quadro	1/2"	Pressione aria raccomandata	6,2 bar
Capacità bullone	M16	Pressione sonora	91,1±3 dB(A)
Coppia massima	861 Nm	Potenza sonora	108,1±3 dB(A)
Coppia di lavoro	150÷220 Nm	Vibrazioni	9,57 m/s <sup>2</sup>
Impulsi al minuto	1650	Attacco aria	1/4"
Velocità a vuoto	10.000 giri/min	Diametro interno tubo aria	10 mm
Consumo medio aria	127 l/min	Peso	1,3 kg



**NEW**

Modulare con i cassetti  
dei carrelli USAG

1 1/2"

12  
PEZZI



## 943 PC1/C12

Cod. U09430005



Assortimento in cassetta modulare con  
avvitatore ad impulsi e bussole macchina

€ 588,00 | € 368,00

DESCRIZIONE	ART./MISURA	PZ.
Avvitatore ad impulsi in magnesio	943 PC1 1/2	1
Chiavi a bussola macchina con bocca esagonale	235 1/2 M/ 10-13-17-18- 19-22-24-27-30-32 mm	10
Spina di tenuta	235 MCA/4-6	2
Anello di sicurezza	235 MDA/4-6	2
Prolunghe macchina	236 1/2 M/125	1



**NEW**

Modulare con i cassetti  
dei carrelli USAG

1 1/2"

12  
PEZZI



## 929 PC1/C12

Cod. U09290005



Assortimento in cassetta modulare con  
avvitatore ad impulsi e bussole macchina

€ 487,00 | € 299,00

DESCRIZIONE	ART./MISURA	PZ.
Avvitatore ad impulsi in magnesio	929 PC1 1/2	1
Chiavi a bussola macchina con bocca esagonale	235 1/2 M/ 10-13-17-18- 19-22-24-27-30-32 mm	10
Spina di tenuta	235 MCA/4-6	2
Anello di sicurezza	235 MDA/4-6	2
Prolunghe macchina	236 1/2 M/125	1



**NEW**

Modulare con i cassetti  
dei carrelli USAG

1 1/2"

7  
PEZZI



## 942 PC3/C7

Cod. U09420015



Assortimento in cassetta modulare con  
avvitatore ad impulsi e bussole macchina

€ 290,00 | € 199,00

DESCRIZIONE	ART./MISURA	PZ.
Avvitatore ad impulsi - extra compatto	942 PC3 1/2	1
Chiavi a bussola macchina con bocca esagonale	235 1/2 M/ 13-17- 19-21-22-24 mm	6
Spina di tenuta	235 MCA/4	1
Anello di sicurezza	235 MDA/4	1

## ILLUMINAZIONE A LED

## CARTER IN LEGA DI MAGNESIO

## CORPO IN ALLUMINIO

950 Nm  
1,4 kg



943 PC2 1/2" 1/2"  
Cod. U09430002

Avvitatore ad impulsi in magnesio con LED - Extra compatto

€ 374,00 | € 262,00

### CARATTERISTICHE TECNICHE

Attacco quadro	1/2"	Pressione aria raccomandata	6,2 bar
Capacità bullone	M16	Pressione sonora	95±3 dB(A)
Coppia massima	950 Nm	Potenza sonora	107±3 dB(A)
Coppia di lavoro	200÷270 Nm	Vibrazioni	3,9 m/s <sup>2</sup>
Impulsi al minuto	1400	Attacco aria	1/4"
Velocità a vuoto	10.000 giri/min	Diametro interno tubo aria	10 mm
Consumo medio aria	167 l/min	Peso	1,4 kg

1.490 Nm  
2,8 kg



928 AC1 1/2" 1/2"  
Cod. U09280014

Avvitatore ad impulsi in alluminio

€ 267,00 | € 185,00

### CARATTERISTICHE TECNICHE

Attacco quadro	1/2"	Pressione aria raccomandata	6,2 bar
Capacità bullone	M16	Pressione sonora	90 ±3 dB(A)
Coppia massima	1.490 Nm	Potenza sonora	101 ±3 dB(A)
Coppia di lavoro	135÷380 Nm	Vibrazioni	5,2 m/s <sup>2</sup>
Impulsi al minuto	1.120	Attacco aria	1/4"
Velocità a vuoto	6.500 giri/min	Diametro interno tubo aria	10 mm
Consumo medio aria	147 l/min	Peso	2,8 kg

## TESTA PIATTA E COMPATTA ideale per l'uso in spazi ristretti.

54 Nm

0,5 kg



913 PB2 3/8" 3/8"  
Cod. U09130011

Cricchetto in materiale composito

### CARATTERISTICHE TECNICHE

Attacco quadro	3/8"	Pressione sonora	92±3 dB(A)
Capacità bullone	M10	Potenza sonora	103±3 dB(A)
Coppia massima	54 Nm	Vibrazioni	3,9 m/s <sup>2</sup>
Velocità a vuoto	300 giri/min	Attacco aria	1/4"
Consumo medio aria	110 l/min	Diametro interno tubo aria	6 mm
Pressione aria raccomandata	6,2 bar	Peso	0,5 kg

€ 141,00 | € 99,00

136 Nm  
1,2 kg



913 PC2 1/2" 1/2"  
Cod. U09130017

Cricchetto in materiale composito

### CARATTERISTICHE TECNICHE

Attacco quadro	1/2"	Pressione sonora	99±3 dB(A)
Capacità bullone	M10	Potenza sonora	110±3 dB(A)
Coppia massima	136 Nm	Vibrazioni	9,1 m/s <sup>2</sup>
Velocità a vuoto	280 giri/min	Attacco aria	1/4"
Consumo medio aria	113 l/min	Diametro interno tubo aria	10 mm
Pressione aria raccomandata	6,2 bar	Peso	1,2 kg

€ 213,00 | € 149,00

## CARTER IN LEGA DI TITANIO



2.115 Nm  
3,8 kg

942 PD1 3/4" 3/4"

Cod. U09420004

Avvitatore ad impulsi in titanio

~~€ 784,00~~ | **€ 549,00**

### CARATTERISTICHE TECNICHE

Attacco quadro	3/4"	Pressione aria raccomandata	6,2 bar
Capacità bullone	M27	Pressione sonora	97,8±3 dB(A)
Coppia massima	2.115 Nm	Potenza sonora	108,8±3 dB(A)
Coppia di lavoro	500÷800 Nm	Vibrazioni	5,06 m/s <sup>2</sup>
Impulsi al minuto	950	Attacco aria	3/8"
Velocità a vuoto	5.300 giri/min	Diametro interno tubo aria	10 mm
Consumo medio aria	200 l/min	Peso	3,8 kg



1.700 Nm  
5,6 kg

928 D1 3/4" 3/4"

Cod. U09280015

Avvitatore ad impulsi in alluminio

~~€ 713,00~~ | **€ 499,00**

### CARATTERISTICHE TECNICHE

Attacco quadro	3/4"	Pressione aria raccomandata	6,2 bar
Capacità bullone	M24	Pressione sonora	98,4±3 dB(A)
Coppia massima	1.700 Nm	Potenza sonora	109,4±3 dB(A)
Coppia di lavoro	500÷1.050 Nm	Vibrazioni	9,1 m/s <sup>2</sup>
Impulsi al minuto	790	Attacco aria	3/8"
Velocità a vuoto	5.700 giri/min	Diametro interno tubo aria	13 mm
Consumo medio aria	193 l/min	Peso	5,6 kg



3.390 Nm  
6,8 kg

942 PE1 1" 1"

Cod. U09420005

Avvitatore ad impulsi in materiale composito

~~€ 956,00~~ | **€ 669,00**

### CARATTERISTICHE TECNICHE

Attacco quadro	1"	Pressione aria raccomandata	6,2 bar
Capacità bullone	M38	Pressione sonora	100,9 ±3 dB(A)
Coppia massima	3.390 Nm	Potenza sonora	111,9 ±3 dB(A)
Coppia di lavoro	203÷1.627 Nm	Vibrazioni	10,6 m/s <sup>2</sup>
Impulsi al minuto	900	Attacco aria	1/2"
Velocità a vuoto	5.000 giri/min	Diametro interno tubo aria	19 mm
Consumo medio aria	400 l/min	Peso	6,8 kg



3.390 Nm  
9 kg

942 PEL2 1" 1"

Cod. U09420007

Avvitatore reversibile in linea in materiale composito

~~€ 999,00~~ | **€ 699,00**

### CARATTERISTICHE TECNICHE

Attacco quadro	1"	Pressione aria raccomandata	6,2 bar
Capacità bullone	M38	Pressione sonora	105 ±3 dB(A)
Coppia massima	3.390 Nm	Potenza sonora	116 ±3 dB(A)
Coppia di lavoro	203÷1.627 Nm	Vibrazioni	15,6 m/s <sup>2</sup>
Impulsi al minuto	1000	Attacco aria	1/2"
Velocità a vuoto	5.000 giri/min	Diametro interno tubo aria	19 mm
Consumo medio aria	480 l/min	Peso	9 kg

**152**  
mm

**5**  
mm

**105**  
l/min

**COMPATTA**  
221 mm



## 920 AN1

Cod. U09200011

**Levigatrice roto-orbitale**

### CARATTERISTICHE TECNICHE

Potenza	0,19 Kw
Capacità disco	Ø 152 mm
Orbita	5 mm
Orbite al minuto	10.000 giri/min
Consumo medio aria	105 l/min
Pressione aria raccomandata	6,2 bar
Pressione sonora	78,9±3 dB(A)
Potenza sonora	79,9±3 dB(A)
Vibrazioni	11,8 m/s <sup>2</sup>
Attacco aria	1/4"
Diametro interno tubo aria	10 mm
Peso	0,8 kg



~~€ 284,00~~ | **€ 199,00**

**10.000**  
Cicli/min

**230**  
l/min

**800**  
g



## 923 A

Cod. U09230001

**Seghetto alternativo**

### CARATTERISTICHE TECNICHE

Cicli al minuto	10.000
Consumo medio aria	230 l/min
Attacco aria	1/4"
Pressione aria raccomandata	6,2 bar
Diametro interno tubo aria	10 mm
Pressione sonora	83,5±3 dB(A)
Potenza sonora	94,5±3 dB(A)
Vibrazioni	17,1 m/s <sup>2</sup>
Peso	800 g



~~€ 231,00~~ | **€ 162,00**



**125**  
mm

**750 W**

**12.000**  
Giri/min

## 921 A4

Cod. U09210012

**Smerigliatrice angolare**

### CARATTERISTICHE TECNICHE

Diametro disco	Ø 125 mm
Diametro attacco disco	Ø 24 mm
Potenza	0,75 Kw
Velocità a vuoto	12.000 giri/min
Consumo medio aria	120 l/min
Pressione aria raccomandata	6,2 bar
Pressione sonora	86±3 dB(A)
Potenza sonora	94±3 dB(A)
Vibrazioni	2,5 m/s <sup>2</sup>
Attacco aria	1/4"
Peso	1,9 Kg



~~€ 284,00~~ | **€ 199,00**

**CAVO 16 m**  
**Ø 10 mm**

## 939 C1

Cod. U09390004

**Avvolgitubo aria**

### CARATTERISTICHE TECNICHE

Lunghezza tubo	16 m
Diametro interno tubo	10 mm
Pressione max di utilizzo	15 bar
Raccordo in uscita	3/8"
Dimensioni (inclusa staffa)	450x400x230 mm
Peso	8 kg



~~€ 283,00~~ | **€ 198,00**



30.000 Giri/min



922 B1

Cod. U09220001

Smerigliatrice dritta

**CARATTERISTICHE TECNICHE**

Consumo medio aria	76 l/min	Vibrazioni	2,42 m/s <sup>2</sup>
Pressione aria raccomandata	6,2 bar	Attacco aria	1/4"
Pressione sonora	84,8±3 dB(A)	Diametro interno tubo aria	10 mm
Potenza sonora	99,5±3 dB(A)	Peso	440 g

~~€ 99,00~~ | € 69,00

25.000 Giri/min



922 B2

Cod. U09220002

Smerigliatrice dritta alta potenza

**CARATTERISTICHE TECNICHE**

Consumo medio aria	113 l/min	Vibrazioni	1,86 m/s <sup>2</sup>
Pressione aria raccomandata	6,2 bar	Attacco aria	1/4"
Pressione sonora	85,4±3 dB(A)	Diametro interno tubo aria	10 mm
Potenza sonora	99,8±3 dB(A)	Peso	675 g

~~€ 113,00~~ | € 79,00

23.000 Giri/min



90°



922 BP1

Cod. U09220004

Smerigliatrice angolare 90°

**CARATTERISTICHE TECNICHE**

Consumo medio aria	76 l/min	Vibrazioni	4,54 m/s <sup>2</sup>
Pressione aria raccomandata	6,2 bar	Attacco aria	1/4"
Pressione sonora	85,9±3 dB(A)	Diametro interno tubo aria	10 mm
Potenza sonora	96,9±3 dB(A)	Peso	555 g

~~€ 141,00~~ | € 99,00

24.000 Giri/min



120°



922 BR1

Cod. U09220005

Smerigliatrice angolare 120°

**CARATTERISTICHE TECNICHE**

Consumo medio aria	76 l/min	Vibrazioni	5,22 m/s <sup>2</sup>
Pressione aria raccomandata	6,2 bar	Attacco aria	1/4"
Pressione sonora	84,8±3 dB(A)	Diametro interno tubo aria	10 mm
Potenza sonora	95,8±3 dB(A)	Peso	560 g

~~€ 141,00~~ | € 99,00

28.000 Giri/min



922 BL1

Cod. U09220003

Smerigliatrice mandrino lungo

**CARATTERISTICHE TECNICHE**

Consumo medio aria	76 l/min	Vibrazioni	2,86 m/s <sup>2</sup>
Pressione aria raccomandata	6,2 bar	Attacco aria	1/4"
Pressione sonora	83,3±3 dB(A)	Diametro interno tubo aria	10 mm
Potenza sonora	94,3±3 dB(A)	Peso	664 g

~~€ 141,00~~ | € 99,00

**NEW**



**6**  
PEZZI

**1 2"**

mm  $\rightarrow$  210  
 $\downarrow$  60  
 $\nearrow$  130

## 233 1/2" MNTX/C6

Cod. U02332514



Assortimento in cassetta di ABS con bussole per viti con impronta TORX®

DESCRIZIONE	ART./MISURA	PZ.
Chiavi a bussola macchina per viti con impronta TORX®	233 1/2 MNTX T30-T40-T45-T50-T55-T60	6

~~€ 94,60~~ | **€ 66,50**



**16**  
PEZZI

**1 2"**

mm  $\rightarrow$  210  
 $\downarrow$  60  
 $\nearrow$  130

## 687 1/2" C16

Cod. U06870100



Assortimento in cassetta di ABS con inserti macchina

DESCRIZIONE	ART./MISURA	PZ.
Portainseri	685 6 1/2	1
Portainseri	685 8 5/16	1
Inserti esagono maschio 1/2	687 E 6-7-8-10-12-14	6
Inserti TORX 1/2	687 TX T30-T40-T45-T50-T55	5
Inserti PHILLIPS 5/16	686 PH 2-3-4	3

~~€ 147,00~~ | **€ 89,00**



**6**  
PEZZI

**3 4"**

mm  $\rightarrow$  210  
 $\downarrow$  60  
 $\nearrow$  130

## 688 3/4" MD6

Cod. U06880010



Assortimento in cassetta di ABS con inserti macchina

DESCRIZIONE	ART./MISURA	PZ.
Portainseri	685 B 1 7/8	1
Inserti esagono maschio 7/8	688 E 12-17-19-22-24	5

~~€ 191,00~~ | **€ 134,00**



## Gamma porta inserti 685 B e inserti macchina 688

### ANTICORROSIONE E ANTIUSURA

Acciaio al cromo molibdeno e fosfatazione al manganese.

**ISO 9227**

### SPINA DI TENUTA

Garantisce maggior tenuta dell'inserto nella sede rispetto al grano di bloccaggio.

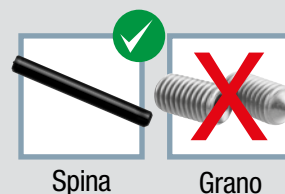

Spina

Grano

Modulare con i cassetti  
dei carrelli USAG



**NEW**

**235 1/2" M/C16**

Cod. U02359285



Assortimento in cassetta modulare  
con bussole macchina esagonali

DESCRIZIONE	ART./MISURA	PZ.
Chiavi a bussola macchina con bocca esagonale	235 1/2 M 10-12-13-14-15-16-17-18-19-21-22-24-27-30-32 mm	15
Spina di tenuta	235 MCA/4-6	2
Anello di sicurezza	235 MDA/4-6	2
Prolunghe macchina	236 1/2 M/125	1

**16**  
PEZZI

**1 1/2"**

~~€ 200,70~~ | **€ 99,00**

← 375  
↑ 80  
mm ↗ 186



**7**  
PEZZI

**3 1/4"**

**235 3/4" M/D7**

Cod. U02359284



Assortimento in cassetta di metallo  
con bussole macchina

DESCRIZIONE	ART./MISURA	PZ.
Chiavi a bussola macchina con bocca esagonale	235 3/4 M 17-19-22-24-27-30-32	7

~~€ 174,00~~ | **€ 122,00**

← 320  
↑ 57  
mm ↗ 205

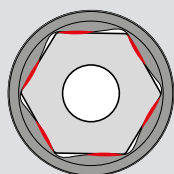

**ISO 2725-2**  
**ISO 1174-2**

## Gamma bussole esagonali macchina

### PROFILO MIGLIORATO

Maggiore contatto tra bussola e superficie piana di dado o vite.

### ESECUZIONE FOSFATATA

**ISO 9227**

### MARCATURA LASER

Logo e misura più visibile (misure 1" e 1 1/2" per incisione).

### ACCIAIO SPECIALE

Cromo molibdeno per superiore resistenza agli impatti.

# IL CATALOGO COMPLETO A PORTATA DI MANO E SEMPRE AGGIORNATO!

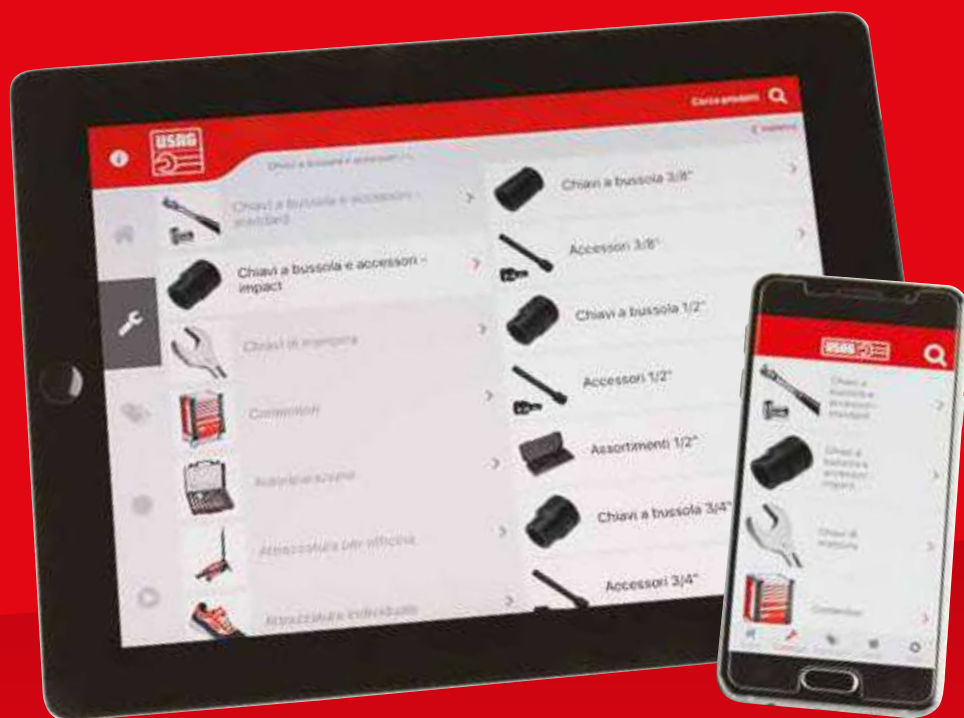

## Scarica l'App!

- Funziona offline.
- Notifiche push.
- Leggera.



## SU SMARTPHONE E TABLET.



Stanley Black & Decker Italia S.r.l.  
Via Volta, 3 - 21020 Monvalle (VA)  
Tel. +39 0332 790111  
Fax +39 0332 790330  
info.mv@usag.it

**usag.it**



**Offerta valida fino al 31 gennaio 2022 salvo esaurimento scorte, presso i Rivenditori che aderiscono all'iniziativa.** Tutti i prezzi sono da intendersi in Euro, IVA esclusa. Le immagini riprodotte in questa brochure sono indicative. Stanley Black & Decker Italia S.r.l. si riserva in ogni momento di modificare le caratteristiche tecniche dei prodotti.

TIMBRO DEL RIVENDITORE